

REV.	DATE	ECO	DESCRIPTION	BY	CK	APP
-	8/26/2013	N/A	INITIAL RELEASE	GDR	N/A	N/A

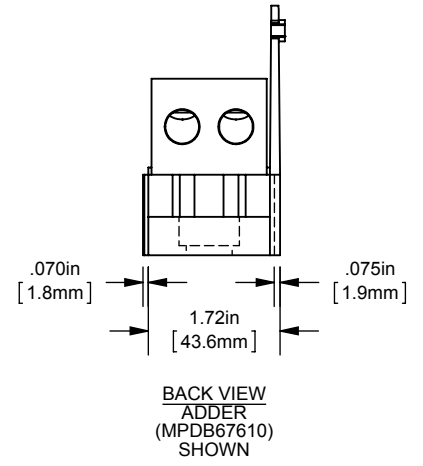

DIMENSIONS IN [] ARE MILLIMETERS

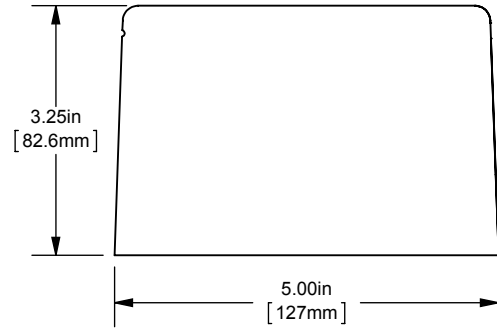
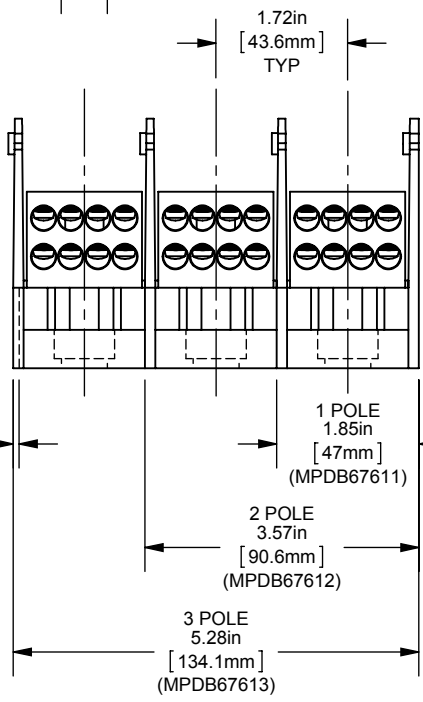
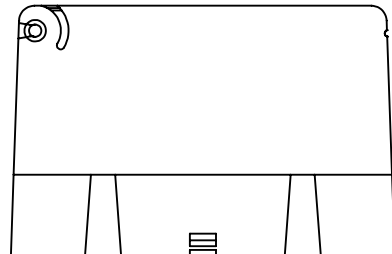
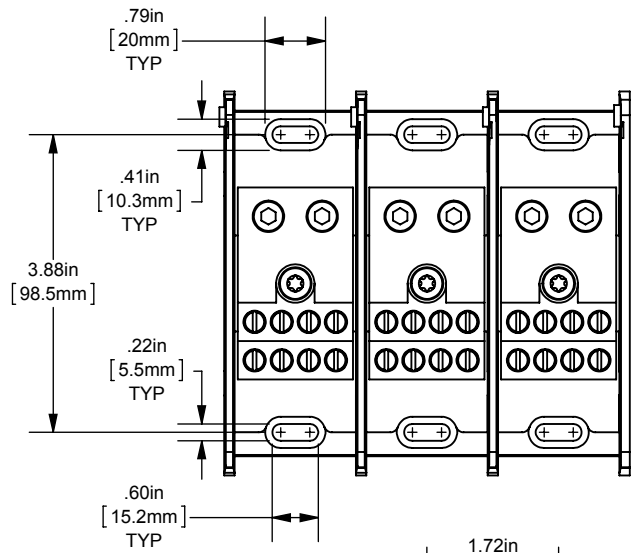

MERSEN USA NEWBURYPORT-MA, LLC
374 MERRIMAC STREET
NEWBURYPORT, MA 01950

MPDB(67610,67611,67612,67613)

PDB 1-3, ADDER ALUMINUM INTERMEDIATE

(2) 2/0-14 X (8) 2-14

OUTLINE DIMENSIONS
NOT TO BE USED FOR PRODUCTION

701966

PRODUCT MANAGER
SIGN:
DATE:

DESIGN ENGINEER
SIGN:
DATE: (SEE ECO)