

REV.	DATE	ECO	DESCRIPTION	BY	CK	APP
-	8/23/2013	NA	INITIAL RELEASE	LDB	NA	NA

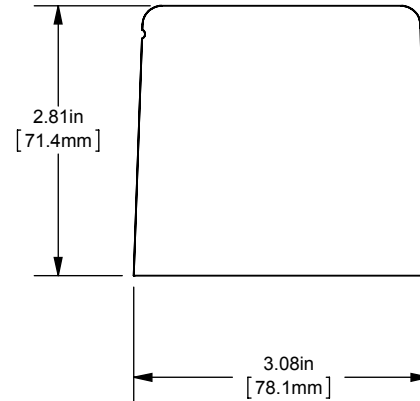

REAR VIEW SHOWING ADDER

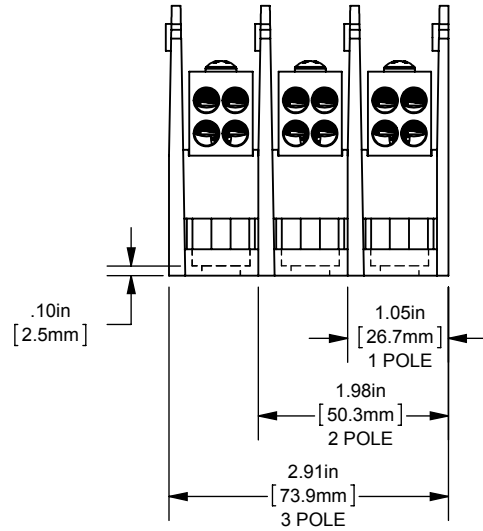
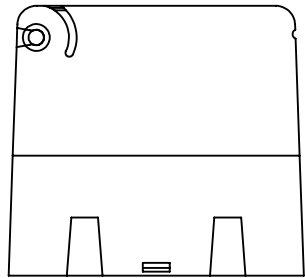
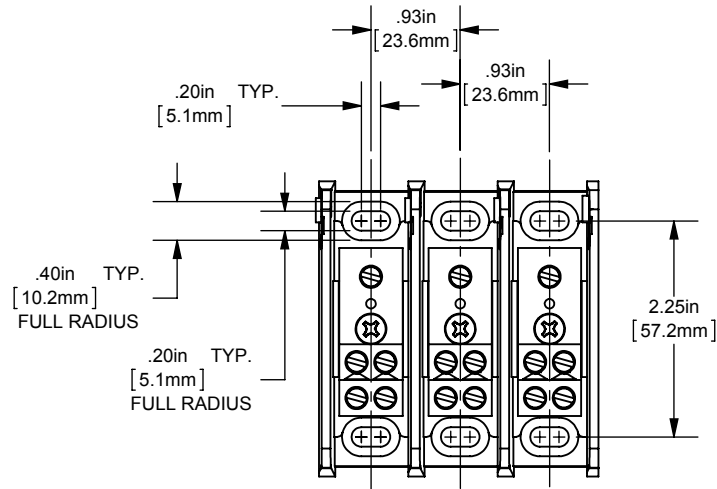
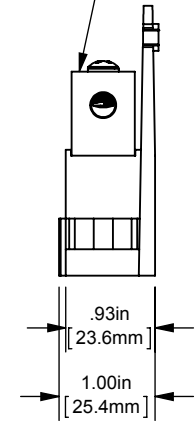

DIMENSIONS IN [ ] ARE MILLIMETERS



MERSEN USA NEWBURYPORT-MA, LLC  
374 MERRIMAC STREET  
NEWBURYPORT, MA 01950

MPDB6216(0,1,2,3)

PDB -ADDER, 1 TO 3 POLES

(1) 4-14 X (4) 4-14 COPPER

OUTLINE DIMENSIONS  
NOT TO BE USED FOR PRODUCTION

701959

PRODUCT MANAGER

SIGN:

DATE:

DESIGN ENGINEER

SIGN:

DATE: