

REV.	DATE	ECO	DESCRIPTION	BY	CK	APP
-	6-10-11	N/A	INITIAL RELEASE	LDB	N/A	N/A

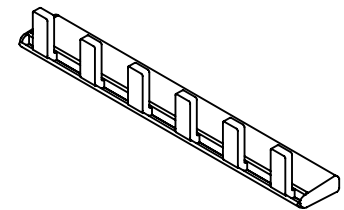

DIMENSIONS IN [ ] ARE MILLIMETERS

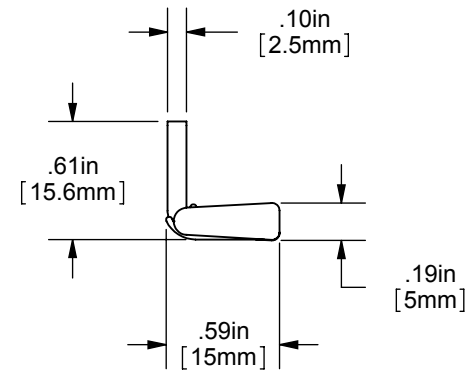
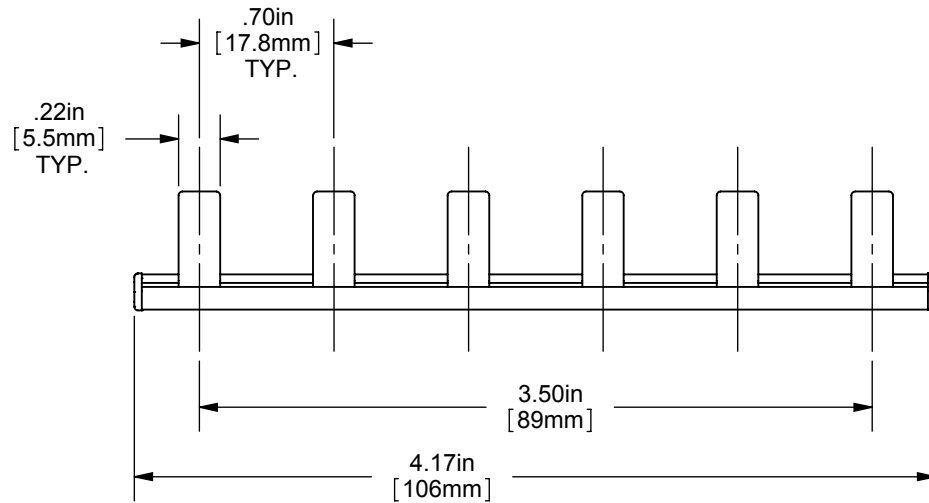
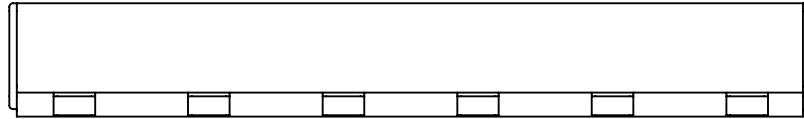

MERSEN USA NEWBURYPORT-MA, LLC  
374 MERRIMAC STREET  
NEWBURYPORT, MA 01950

USBB1PH25K6

BUSBAR 1-PHASE 6-POLE

100A 600VAC/1000VDC

OUTLINE DIMENSIONS  
NOT TO BE USED FOR PRODUCTION

701719

PRODUCT MANAGER

SIGN:

DATE:

DESIGN ENGINEER

SIGN:

DATE: