



Your problem: Whether your objective is optimum protection of motor control equipment, power or control transformers, cable wiring, or lighting and heating circuits — you need fast, accurate information to do the job right. Problem is, not all electrical pros have the same familiarity with circuit protection theories and practices.

Our solution: Every application has its unique challenges. But you'll find the path to a basic understanding of applied circuit protection principles in our Applications section. Be it a glossary of relevant electrical terms, an introduction to fuse construction, guidance on reading and applying Peak Let-thru curves, or a look at the most common applications.

Want more information fast? For more technical or application-specific information, please call our Applications Engineering experts at 978-465-4853 or visit our website at ep.mersen.com.

Application Information

**NEED TO KNOW HOW?
YOU'VE TURNED TO
THE RIGHT PLACE...
LITERALLY**

- Definitions AP 2
- Fuse Descriptions AP 4
- Fuse Construction & Operation AP 4
- How to Read a Time Current Curve. AP 5
- Low Voltage Motor Protection AP 6
- Transformer Protection AP 11
 - General. AP 11
 - Low Voltage Primary Protection AP 11
 - Primary and Secondary Fuses for LV Transformers AP 12
 - Control Transformers. AP 13
 - MV Transformers AP 14
- Let-Thru Current & I²T. AP 20
- Fuse Let-Thru Current Tables. AP 21
- Capacitor Protection AP 27
- Cable Protection AP 29
- Motor Starter General Info. . AP 30
- Auxiliary Contacts. AP 31
- Selectivity Between Fuses. . AP 32
- Short Circuit Calculations . . AP 33
- Short Circuit Rating AP 34
- 11 Reasons for Using Current-Limiting Fuses. AP 34
- Fuse Obsolescence. AP 35
- Suggested Fuse Specifications. AP 36

Ampacity

The current a conductor can carry continuously without exceeding its temperature rating. Ampacity is a function of cable size, insulation type and the conditions of use.

Ampere Rating

The continuous current carrying capability of a fuse under defined laboratory conditions. The ampere rating is marked on each fuse. Class L fuses and E rated fuses may be loaded to 100% of their ampere rating. For all other fuses, continuous load current should not exceed 80% of fuse ampere rating.

Available Fault Current

The maximum short circuit current that can flow in an unprotected circuit.

Bolt-in Fuse

A fuse which is intended to be bolted directly to bus bars, contact pads or fuse blocks.

Contacts

The external live parts of the fuse which provide continuity between the fuse and the balance of the circuit. Also referred to as ferrules, blades or terminals.

Coordination

The use of overcurrent protective devices which will isolate only that portion of an electrical system which has been overloaded or faulted. See Selectivity.

Current-Limiting Fuse

A fuse which will limit both the magnitude and duration of current flow under short circuit conditions.

Current-Limiting Range

The available fault current a fuse will clear in less than 1/2 cycle, thus limiting the actual magnitude of current flow.

Dual Element Fuse

Often confused with time delay, dual element is a term describing fuse element construction. A fuse having two current responsive elements in series.

Element

A calibrated conductor inside a fuse which melts when subjected to excessive current. The element is enclosed by the fuse body and may be surrounded by an arc-quenching medium such as silica sand. The element is sometimes referred to as a link.

Fault

An accidental condition in which a current path becomes available which by-passes the connected load.

Fault Current

The amount of current flowing in a faulted circuit.

Fuse

An overcurrent protective device containing a calibrated current carrying member which melts and opens a circuit under specified overcurrent conditions.

I²t (Ampere Squared Seconds)

A measure of the thermal energy associated with current flow. I²t is equal to $(I_{RMS})^2 \times t$, where t is the duration of current flow in seconds.

Clearing I²t is the total I²t passed by a fuse as the fuse clears a fault, with t being equal to the time elapsed from the initiation of the fault to the instant the fault has been cleared.

Melting I²t is the minimum I²t required to melt the fuse element.

Interrupting Rating (Abbreviated I.R.)

The maximum current a fuse can safely interrupt. Some special purpose fuses may also have a "Minimum Interrupting Rating". This defines the minimum current that a fuse can safely interrupt.

Kiloamperes (abbreviated kA)

1,000 amperes.

Limiting or Back-up Fuse

A special purpose fuse which is intended to provide short circuit protection only.

Overcurrent

Any current in excess of conductor ampacity or equipment continuous current rating.

Overload

The operation of conductors or equipment at a current level that will cause damage if allowed to persist.

Peak Let-Thru Current (I_p)

The maximum instantaneous current passed by a current-limiting fuse when clearing a fault current of specified magnitude.

Rejection Fuse Block

A fuse block which will only accept fuses of a specific UL class. Rejection is a safety feature intended to prevent the insertion of a fuse with an inadequate voltage or interrupting rating.

Rejection Fuse

A current-limiting fuse with high interrupting rating and with unique dimensions or mounting provisions.

Renewable Fuse

A fuse which can be restored for service by the replacement of its element.

Renewable Element or Link

The field-replaceable element of a renewable fuse. Also referred to as a renewable link.

Selectivity

A main fuse and a branch fuse are said to be selective if the branch fuse will clear all overcurrent conditions before the main fuse opens. Selectivity is desirable because it limits outage to that portion of the circuit which has been overloaded or faulted. Also called selective coordination.

Semiconductor Fuse

An extremely fast acting fuse intended for the protection of power semiconductors. Sometimes referred to as a rectifier or ultra fast fuse.

Short Circuit

Excessive current flow caused by insulation breakdown or wiring error.

Threshold Current

The minimum available fault current at which a fuse is current limiting.

Time-Delay Fuse

A fuse which will carry an overcurrent of a specified magnitude for a minimum specified time without opening. The specified current and time requirements are defined in the UL/CSA/NOM 248 fuse standards.

Voltage Rating

The maximum voltage at which a fuse is designed to operate. Voltage ratings are assumed to be for AC unless specifically labeled as DC.

High Voltage (over 34,500V)

Expulsion-Type power fuses are available for nominal voltages of 46, 69, 115, 138 and 161kV in current ratings up to 400 amperes. ANSI (American National Standards Institute) Standards are followed.

Medium Voltage (601-34,500V)**Current-Limiting or Expulsion-Type Power Fuses**

are general purpose fuses available for nominal voltages of 2.4, 2.75, 4.16, 5.5, 7.2, 8.25, 14.4, 15.5, 23 and 34.5kV in current ratings up to 720 amperes. ANSI and UL Standards are followed.

Current-Limiting Motor Starter Fuses

are available for nominal voltages of 2.4, 4.8 and 7.2kV in current ratings up to 36R (650A). These are special purpose R-Rated fuses for motor short circuit protection only (back-up fuses) and are not full-range power fuses. ANSI and UL Standards are followed.

PT Fuses (Potential Transformers)

require current limiting fuses or equivalent on the primary connection side. Standard PT primary voltages range from 2.4kV to 36kV. Since the power requirement is low (for relays, metering, etc.) fuses of the proper voltage are applied in the 1/2 to 5 ampere range. Several voltage ratings are available, physical sizes vary among manufacturers.

Low Voltage (600V or less)

Many types of low voltage fuses are classified and identified for use in 125, 250, 300, 480, or 600V circuits. UL/CSA/NOM standards are followed. Common types are briefly summarized in the chart on the next page.

SUMMARY OF LOW VOLTAGE FUSES

Fuse Type	Voltage	Ampere Rating	Interrupting Rating – kA	Mersen Part #	UL
Class CC	600VAC 300VDC 600VDC	0-30 0-30 0-30	200 100 100	ATDR, ATQR, ATMR ATDR, ATQR ATMR	248-4
Class G	480/600VAC	0-20/21-60	100	AG	248-5
Class H (Renewable)	250/600VAC	0-600	10	RF/RFS	248-7
Class H (Non-Renew)	250/600VAC	0-600	10	NRN, CRN/NRS, CRS	248-6
Class J	600VAC 300VDC 500VDC	0-600 0-30 0-600	200 100 100	AJT, HSJ, A4J A4J, HSJ(1-10) AJT, HSJ(15-600)	248-8
Class K-5	250/600VAC	0-600	50	OT, OTN/OTS	248-9
Class L	600VAC 500VDC	601-6000 601-3000	200 100	A4BQ, A4BY, A4BT A4BQ	248-10
Class RK1	250/600VAC 600VAC 250VDC 600VDC	0-600 70-600 0-600 0-600	200 200 100 100	A2D, A2K/A6D, A6K A2D A6D	248-12
Class RK5	250/600VAC 300/600VDC	0-600 0-30/35-400	200 20	TR/TRS TRS-RDC	248-12
Class T	300/600VAC 160/300VDC	0-1200/0-800 0-1200	200 50/100	A3T/A6T A3T/A6T	248-15
Glass/Electronic	32-350VAC	0-30	Up to 10	See Section MF	248-14
Midget	125/250VAC 500/600VAC	0-30 0-30	0.2-10 10,100	TRM, OTM, GFN ATQ, ATM, SBS	248-14
Cable Protector	250VAC 600VAC	1-500kcmil Cu or Al #2-1000kcmil Cu or Al	200 200	2CL CP, CPH	248-1
Capacitor	600-5500VAC	25-300	Up to 200	A100C-A550C	Other
Welder	600VAC	100-600	200	A4BX	Other
Photovoltaic				See Section MF	

FUSE CONSTRUCTION AND OPERATION

The typical fuse consists of an element which is surrounded by a filler and enclosed by the fuse body. The element is welded or soldered to the fuse contacts (blades or ferrules).

The element is a calibrated conductor. Its configuration, its mass, and the materials employed are selected to achieve the desired electrical and thermal characteristics. The element provides the current path through the fuse. It generates heat at a rate that is dependent upon its resistance and the load current.

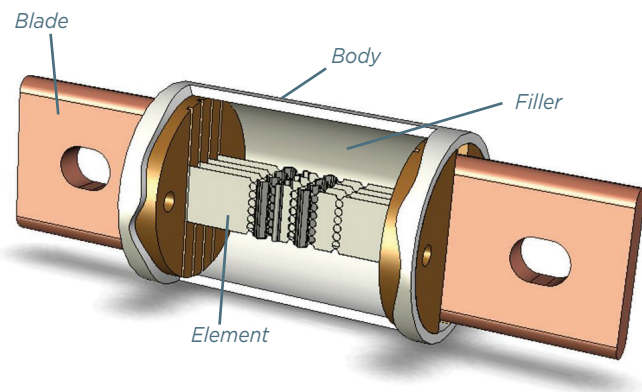

The heat generated by the element is absorbed by the filler and passed through the fuse body to the surrounding air. A filler such as quartz sand provides effective heat transfer and allows for the small element cross-section typical in modern fuses. The effective heat transfer allows the fuse to carry harmless overloads. The small element cross section melts quickly under short circuit conditions. The filler also aids fuse performance by absorbing arc energy when the fuse clears an overload or short circuit.

When a sustained overload occurs, the element will generate heat at a faster rate than the heat can be passed to the filler. If the overload persists, the element will reach its melting point and open. Increasing the applied current will heat the element faster and cause the fuse to open sooner. Thus fuses have an inverse time current characteristic, i.e. the greater the overcurrent the less time required for the fuse to open the circuit.

This characteristic is desirable because it parallels the characteristics of conductors, motors, transformers and other electrical apparatus. These components can carry low level overloads for relatively long times without damage. However, under high current conditions damage can occur quickly. Because of its inverse time current characteristic, a properly applied fuse can provide effective protection over a broad current range, from low level overloads to high level short circuits.

HOW TO READ A TIME-CURRENT CURVE

A time-current characteristic curve, for any specified fuse, is displayed as a continuous line representing the average melting time in seconds for a range of overcurrent conditions. The melting time is considered nominal unless noted otherwise. Several curves are traditionally shown on one sheet to represent a family of fuses. The family shown here is the Time Delay Class J AJT Amp-Trap 2000® fuse.

Information can be accessed from these curves in several ways:

- If a fuse has been selected, the designer can use the curve for that fuse to check its opening time versus a given overcurrent. Example: Using the 30 ampere fuse curve, what is the fuse opening time in seconds at a current of 160 amperes? At the bottom of the sheet (Current in Amperes) find 160 amperes (Pt. A) and follow that line straight up until it intersects the 30A curve (Pt. B). Then follow that line to the left edge (Time in Seconds) and read 10 seconds. (Pt. C). This tells us that the AJT30 will open in 10 seconds on a current of 160 amperes.
- Likewise, for the same fuse we might want to know what current will open the fuse in 0.1 second. On the vertical axis (Time in Seconds) find 0.1 second (Pt. D) and follow that line to the right until it intersects the 30A curve (Pt. E). Then follow that line straight down to the horizontal axis (Current in Amperes) and read 320 amperes (Pt. F). This shows that the AJT30 requires an overcurrent of 320 amperes to open in 0.1 second.
- The curves can be used in other ways by the designer. For example, if a family has been chosen (i.e. Time Delay Class J AJT) and an opening time of approximately 1 second is required at 3000 amperes, what fuse in the

family best meets this need? Find the 3000 ampere line on the horizontal axis (Pt. G) and follow it up to the 1 second line (Pt. H). The nearest curve to the right is the AJT400. If the point is not near a curve shown, other intermediate curves are available from the factory.

Sometimes the fuse family or type has not been chosen, so a design requirement can be presented to several family characteristic curves. One fuse type will emerge as a good choice. Voltage rating, interrupting rating, physical size, time delay, etc. are all considerations in the final choice.

AJT TIME DELAY / CLASS J

Melting Time -Current Data 1-600 Amperes, 600 Volts AC

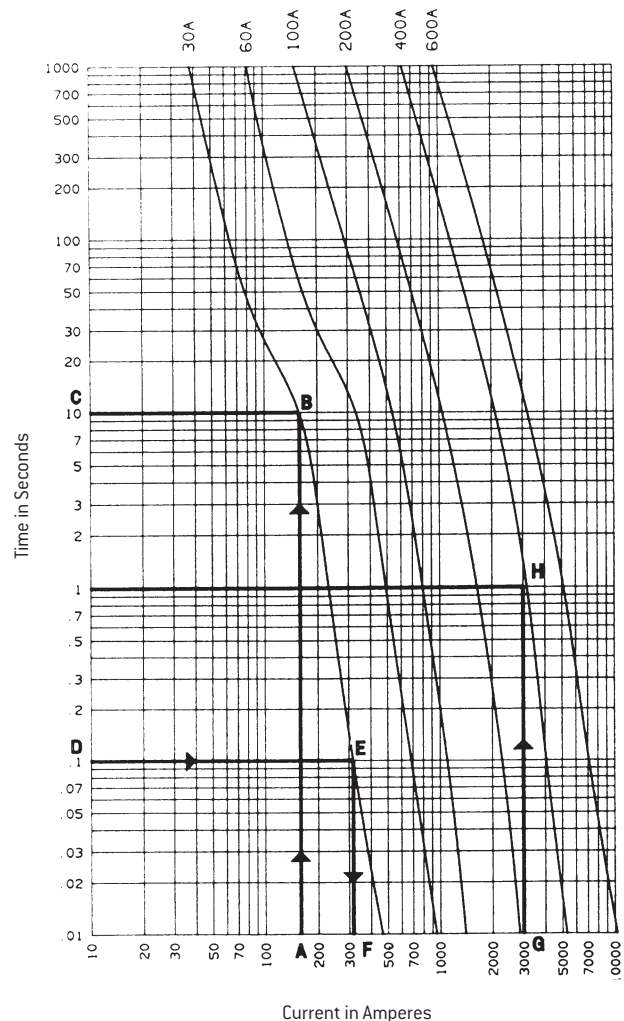

CODE REQUIREMENTS

The NEC or CEC requires that motor branch circuits be protected against overloads and short circuits. Overload protection may be provided by fuses, overload relays or motor thermal protectors. Short circuit protection may be provided by fuses or circuit breakers.

OVERLOAD PROTECTION

The NEC or CEC allows fuses to be used as the sole means of overload protection for motor branch circuits. This approach is often practical with small single phase motors. If the fuse is the sole means of protection, the fuse ampere rating must not exceed the values shown in Table 1.

Most integral horsepower 3 phase motors are controlled by a motor starter which includes an overload relay. Since the overload relay provides overload protection for the motor branch circuit, the fuses may be sized for short circuit protection.

SHORT CIRCUIT PROTECTION

The motor branch circuit fuses may be sized as large as shown in Table 2 when an overload relay or motor thermal protector is included in the branch circuit. Time delay fuse ratings may be increased to 225% and non-time delay fuse ratings to 400% (300% if over 600 amperes) if the ratings shown in Table 2 will not carry motor starting current.

Some manufacturers' motor starters may not be adequately protected by the maximum fuse sizing shown in Table 2. If this is the case, the starter manufacturer is required by UL 508 to label the starter with a maximum permissible fuse size. If so labeled, this maximum value is not to be exceeded.

Where the percentages shown in Table 2 do not correspond to standard fuse ratings the next larger fuse rating may be used. Standard fuse ratings in amperes:

15	20	25	30	35	40	45	50
60	70	80	90	100	110	125	150
175	200	225	250	300	350	400	450
500	600	700	800	1000	1200	1600	2000
2500	3000	4000	5000	6000			

FUSE SELECTION GUIDELINES

What fuse type and ampere rating is best for a given application? The answer depends upon the application and objective to be met. Here are some suggestions.

WHICH FUSE CLASS?

UL Classes RK5, RK1, and J are the most popular. The Class RK5 (Tri-onic®) is the least expensive. The Class RK1 (Amp-Trap®) is used where a higher degree of current limitation is required for improved component protection or system coordination. The RK5 and RK1 are dimensionally interchangeable.

The Class J time delay fuse (AJT) provides advantages over the RK5 and RK1 fuses. Class J fuses provide a higher degree of current limitation than the RK's. This reduced fault current will reduce arc faults in cases of an arc flash incident.

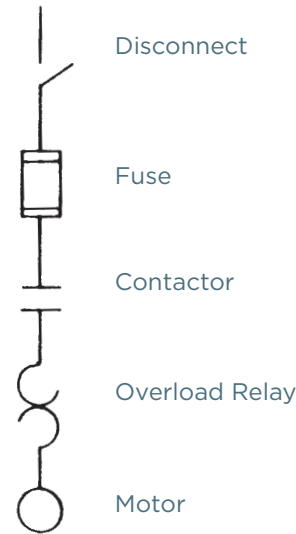

MOTOR BRANCH CIRCUIT

TABLE 1- MAXIMUM FUSE RATING FOR OVERLOAD PROTECTION

Motor Service Factor or Marked Temperature Rise	Fuse Rating as %* Motor Full Load
Service factor of 1.15 or greater	125
Marked temperature rise not Exceeding 40°C	125
All Others	115

* These percentages are not to be exceeded.

TABLE 2- MAXIMUM FUSE RATING FOR SHORT CIRCUIT PROTECTION

Type of Motor	Fuse Rating as %* Motor Full Load*	
	Non-Time Delay	Time Delay
All Single-phase AC motors	300	175
AC polyphase motors other than wound-rotor:		
Squirrel Cage		
Other than Design E	300	175
Design E	300	175
Synchronous	300	175
Wound rotor	150	150
Direct-current (constant voltage)	150	150

* The non-time delay ratings apply to all class CC fuses.

The Class J fuse is also about half the physical size of the RK5 and RK1 reducing panel space and saving money.

TIME DELAY VS. NON-TIME DELAY

Time delay fuses are the most useful fuses for motor branch circuit application. A time delay fuse can be sized closer to motor full load current, providing a degree of overload protection, better short circuit protection, and possible use of a smaller disconnect switch.

WHAT AMPERE RATING?

The selection of fuse ampere rating is a matter of experience and personal preference. Some prefer to size time delay fuses at 125% of motor full load amperes. This sizing will provide a degree of overload protection for motors with a service factor of 1.15. Sizing fuses at 125% of motor nameplate amperes in some applications may result in nuisance fuse openings. Time delay fuses sized at 125% may open at motor locked rotor current before some NEMA Class 20 overload relays operate. Nuisance fuse openings may result if Class RK1 or Class J fuses are sized at 125% of motor full load current. These fuses are more current limiting than the RK5 and have less short time current carrying capability.

Sizing time delay fuses between 125% and 150% of motor full load current provides advantages. The fuse will coordinate with NEMA Class 20 overload relays. Nuisance fuse opening will virtually be eliminated and effective short circuit protection will be maintained.

For newer, premium efficiency motors, sizing fuses between 125% and 150% may not be sufficient enough to handle the expected higher motor locked-rotor currents. For suggestions on sizing fuses for these situations, refer to the high-efficiency sizing summary at the end of this section.

PROTECTING IEC STYLE MOTOR STARTERS

The new IEC European style motor starters and contactors are popular but they present different problems in protection. These devices represent substantial savings in space and cost but they have a lower withstand capability than their NEMA counterparts.

In order to achieve the same level of protection for IEC style devices that we expect for NEMA devices, the AJT Class J Time Delay fuse is the best choice, sized at 1.25 to 1.50 times motor full load amperes. Also, the AJT has the advantage of being half the size of RK5 and RK1 fuses and thereby fits the trim IEC package.

SINGLE PHASE MOTOR FUSE SELECTION UL CLASSES RK1, RK5, J & CC

Motor Characteristics*		Fuse Classes and Ampere Ratings					
Motor HP	Full Load Current	Recommended Rating	Class CC (ATDR)		Class J (AJT) and RK5/1 (TR/A2D)		
			Max. Rating per NEC 430.52(C)(1), Exception No. 1†	Max. Rating per NEC 430.52(C)(1), Exception No. 2††	Recommended Rating	Max. Rating per NEC 430.52(C)(1), Exception No. 1†	Max. Rating per NEC 430.52(C)(1), Exception No. 2††
Single Phase, 115 V							
1/6	4.4	15	15	15	7	10	10
1/4	5.8	17-1/2	20	20	9	15	15
1/3	7.2	25	25	25	12	15	15
1/2	9.8	30	30	30	15	20	20
3/4	13.8	-	-	-	20	25	30
1	16	-	-	-	25	30	35
1-1/2	20	-	-	-	30	35	45
2	24	-	-	-	35	45	50
3	34	-	-	-	60	60	70
5	56	-	-	-	80	100	125
7-1/2	80	-	-	-	125	150	175
10	100	-	-	-	150	175	225
Single Phase, 230 V							
1/6	2.2	7	10	10	3-1/2	6	6
1/4	2.9	9	10	10	4-1/2	6	6
1/3	3.6	12	15	15	5-6/10	10	10
1/2	4.9	15	15	15	7	10	10
3/4	6.9	20	25	25	12	15	15
1	8	25	25	30	12	15	17-1/2
1-1/2	10	30	30	30	15	20	20
2	12	-	-	-	20	25	25
3	17	-	-	-	25	30	35
5	28	-	-	-	40	50	60
7-1/2	40	-	-	-	60	70	90
10	50	-	-	-	80	90	110

* Values obtained from NEC 2017 Table 430.250. Fuse ampere ratings based on percentages of full-load current values from this table.

† Sizing based on 175% of motor FLA for Time-Delay Class J/R fuses and 300% of motor FLA for Time-Delay Class CC fuses. Values rounded up to the next standard rating.

†† Sizing based on 225% of motor FLA for Time-Delay Class J/R fuses and 400% of motor FLA for Time-Delay Class CC fuses. Fuse ratings cannot exceed these values.

THREE PHASE MOTOR FUSE SELECTION UL CLASSES RK5, RK1, J & CC

Motor Characteristics*		Fuse Classes and Ampere Ratings					
Motor HP	Full Load Current	Recommended Rating	Class CC (ATDR)		Class J (AJT) and RK5/1 (TR/A2D)		
			Max. Rating per NEC 430.52(C)(1), Exception No. 1†	Max. Rating per NEC 430.52(C)(1), Exception No. 2††	Recommended Rating	Max. Rating per NEC 430.52(C)(1), Exception No. 1†	Max. Rating per NEC 430.52(C)(1), Exception No. 2††
Three Phase, 208 V							
0.5	2.4	8	10	10	3-1/2	6	6
0.75	3.5	10	15	15	5	10	10
1	4.6	15	15	15	7	10	10
1.5	6.6	20	20	25	10	15	15
2	7.5	25	25	30	12	15	15
3	10.6				15	20	20
5	16.7				25	30	35
7.5	24.2				35	45	50
10	30.8				45	60	60
15	46.2				70	90	100
20	59.4				90	110	125
25	74.8				110	150	150
30	88				150	175	175
40	114				175	200	250
50	143				225	300	300
60	169				250	300	350
75	211				350	400	450
100	273				400	500	600
125	343				500	600	-
150	396				600	-	-
Three Phase, 230 V							
0.5	2.2	7	10	10	3-1/2	6	6
0.75	3.2	10	10	12	5	6	7
1	4.2	12	15	15	6-1/4	10	10
1.5	6	17-1/2	20	20	9	15	15
2	6.8	20	25	25	10	15	15
3	9.6	30	30	30	15	20	20
5	15.2				25	30	30
7.5	22				35	40	45
10	28				40	50	60
15	42				70	80	90
20	54				80	100	110
25	68				110	125	150
30	80				125	150	175
40	104				150	200	225
50	130				200	250	250
60	154				225	300	300
75	192				300	350	400
100	248				350	450	500
125	312				450	600	600
150	360				500	600	-

* Values obtained from NEC 2017 Table 430.250. Fuse ampere ratings based on percentages of full-load current values from this table.

† Sizing based on 175% of motor FLA for Time-Delay Class J/R fuses and 300% of motor FLA for Time-Delay Class CC fuses. Values rounded up to the next standard rating.

†† Sizing based on 225% of motor FLA for Time-Delay Class J/R fuses and 400% of motor FLA for Time-Delay Class CC fuses. Fuse ratings cannot exceed these values.

THREE PHASE MOTOR FUSE SELECTION
UL CLASSES RK5, RK1, J, CC

Motor Characteristics*		Fuse Classes and Ampere Ratings					
Motor HP	Full Load Current	Recommended Rating	Class CC (ATDR)		Class J (AJT) and RK5/1 (TRS/A6D)		
			Max. Rating per NEC 430.52(C)(1), Exception No. 1†	Max. Rating per NEC 430.52(C)(1), Exception No. 2††	Recommended Rating	Max. Rating per NEC 430.52(C)(1), Exception No. 1†	Max. Rating per NEC 430.52(C)(1), Exception No. 2††
Three Phase, 460 V							
0.5	1.1	3-1/2	6	6	1-6/10	3	3
0.75	1.6	5	6	6-1/4	2-1/2	3	3-1/2
1	2.1	6-1/4	10	10	3-2/10	6	6
1.5	3	9	10	12	4-1/2	6	6-1/4
2	3.4	10	15	15	5	6	7
3	4.8	15	15	15	7	10	10
5	7.6	25	25	30	12	15	15
7.5	11				17-1/2	20	20
10	14				20	25	30
15	21				35	40	45
20	27				40	50	60
25	34				50	60	70
30	40				60	70	90
40	52				80	100	110
50	65				100	125	125
60	77				125	150	150
75	96				150	175	200
100	124				200	225	250
125	156				225	300	350
150	180				250	350	400
200	240				350	450	500
250	302				450	600	600
300	361				600	-	-
Three Phase, 575V							
0.5	0.9	2-8/10	3	3-1/2	1-1/2	3	3
0.75	1.3	4	6	6	2	3	3
1	1.7	5-6/10	6	6-1/4	2-8/10	3	3-1/2
1.5	2.4	8	10	10	3-1/2	6	6
2	2.7	8	10	10	4	6	6
3	3.9	12	15	15	6	10	10
5	6.1	17-1/2	20	20	10	15	15
7.5	9	30	30	30	15	20	20
10	11				17-1/2	20	20
15	17				25	30	35
20	22				35	40	45
25	27				40	50	60
30	32				50	60	70
40	41				60	80	90
50	52				80	100	110
60	62				90	110	125
75	77				125	150	150
100	99				150	175	200
125	125				200	225	250
150	144				225	300	300
200	192				300	350	400
250	242				350	450	500
300	289				450	600	600

* Values obtained from NEC 2017 Table 430.250. Fuse ampere ratings based on percentages of full-load current values from this table.

† Sizing based on 175% of motor FLA for Time-Delay Class J/R fuses and 300% of motor FLA for Time-Delay Class CC fuses. Values rounded up to the next standard rating.

†† Sizing based on 225% of motor FLA for Time-Delay Class J/R fuses and 400% of motor FLA for Time-Delay Class CC fuses. Fuse ratings cannot exceed these values.

FUSE SIZING CONSIDERATIONS FOR HIGHER EFFICIENCY MOTORS

When selecting the proper fuse for short circuit protection in motor starting applications, it is important to not only ensure that the fuse will not nuisance open during motor start up times, but also that the fuse will coordinate as required with overload relays. When sizing fuses between 125% and 150% of the motor nameplate current, several advantages, including ease of coordination with an overload device, a smaller disconnect, and increased short circuit protection from a lower fuse rating, can be achieved. However, if sizing at this level prevents the motor from starting, it may then be necessary to increase the fuse ampere rating and it then becomes important to know the NEC sizing limitations.

As of June 1, 2016, the US Department of Energy has mandated that newly manufactured electric motors will need to meet NEMA Premium® efficiency standards. As motor efficiencies increase, motor locked rotor currents can also be expected to increase. In addition to this, with across-the-line starting applications, it is critical to understand not only the locked rotor current, but also the starting time that can be expected.

With previous efficiencies, typically motor locked rotor currents between 300% and 600% of motor nameplate currents were common. However, with the new efficiency standards, locked rotor currents for NEMA Design B, C, and D motors can reach between 600% and 700% of nameplate currents and are restricted to maximum levels per the NEMA design standards. With NEMA Design E motors, these levels can be expected to be as high as 1000% of the rated current. Design A motors have no standardized maximums for locked rotor currents, but can be very high depending on the motor kVA code value. Special attention should be paid to the motor nameplate values when sizing motor protection fuses.

For Premium Efficiency motors, sizing fuses between 125% and 150% of the rated current may not be sufficient to allow the motor to start due to the potential magnitude of locked rotor currents. In addition to this, if the expected start time of the motor is over 5 seconds, this may be too long for this size fuse to handle without opening. Section 430.52(C)(1), Exception 1 in the NEC allows for Time-Delay Class R and J fuses to be sized at 175% of the rated motor current up to the next standard fuse size.

If sizing at 175% still does not allow for the motor to start, section 430.52(C)(1), Exception 2 in the NEC permits an absolute maximum fuse size of 225% of the motor rated current. In these cases, depending on the value determined from these multiplication factors, fuse sizes between Exceptions 1 and 2 may be exactly the same. Where Exception 1 permits rounding up to the next standard size, fuses sized to Exception 2 may not exceed the mentioned 225% value in any way.

For Time-Delay Class CC fuses, similar exceptions in the NEC also apply. Section 430.52(C)(1), Exception 1 allows for a fuse size of 300% up to the next standard rating. Section 430.52(C)(1), Exception 2 permits a fuse size not exceeding 400% of the motor rated current, should 300% sizing still not allow the motor to start.

NEC 430.52 Fuse Sizing Limits		
NEC Sections	Time-Delay Class R/J Fuse	Time-Delay Class CC Fuse
NEC 430.52(C)(1), Exception 1	175%*	300%*
NEC 430.52(C)(1), Exception 2	225%**	400%**

* Values may be rounded up to next standard fuse ampere rating.

** Permitted when Exception 1 ratings are not sufficient for motor starting current. Ratings may not exceed these limits.

This section summarizes transformer overcurrent protection as required by the National Electrical Code (NEC) and Canadian Electric Code.

TRANSFORMERS - PRIMARY 1000 VOLTS OR LESS

If secondary fuse protection is not provided, primary fuses are to be selected according to Table 1. If both primary and secondary fuses are used, they are to be selected according to Table 2.

Table 1 - Primary Fuse Only

Transformer Primary Amperes	Maximum Primary Fuse % Rating
9 or more	125*
2 to less than 9	167
less than 2	300

Table 2 - Primary & Secondary Fuses

Transformer Secondary Amperes	Maximum Primary Fuse % Rating	
	Primary Fuse	Secondary Fuse
9 or more	250	125*
less than 9	250	167

* If 125% does not correspond to a standard ampere rating, the next higher standard rating shall be permitted.

TRANSFORMER MAGNETIZING INRUSH CURRENTS

When voltage is switched on to energize a transformer, the transformer core normally saturates. This results in a large inrush current which is greatest during the first half cycle (approximately 0.01 second) and becomes progressively less severe over the next several cycles (approximately 1 second) until the transformer reaches its normal magnetizing current.

To accommodate this inrush current, fuses are often selected which have time-current withstand values of at least 12 times transformer primary rated current for .1 second and 25 times for .01 second. Recommended primary fuses for popular, low voltage 3-phase transformers are shown on the next page. Some small dry-type transformers may have substantially greater inrush currents. For these applications, the fuse may have to be selected to withstand 45 times transformer primary rated current for .01 second.

SECONDARY FUSES

Selecting fuses for the secondary is simple once rated secondary current is known. Fuses are sized at 125% of secondary FLA or the next higher rating; or at maximum 167% of secondary FLA, see Table 2 for rules. The preferred sizing is 125% of rated secondary current I_{sec} or next higher fuse rating. To determine I_{sec} , first determine transformer rating (VA or kVA), secondary voltage (V_{sec}) and use formulas below.

- Single Phase : $I_{sec} = \frac{\text{Transformer VA}}{V_{sec}}$
or $\frac{\text{Transformer kVA} \times 1000}{V_{sec}}$
- Three Phase : $I_{sec} = \frac{\text{Transformer VA}}{1.73 \times V_{sec}}$
or $\frac{\text{Transformer kVA} \times 1000}{1.73 \times V_{sec}}$

When I_{sec} is determined, multiply it by 1.25 and choose that fuse rating or next higher rating.

$$[I_{sec} \times 1.25 = \text{Fuse Rating}]$$

Fusing for Three Phase Transformer Primaries without Secondary Protection

Transformer kVA	240V Primary		480V Primary		600V Primary	
	FLA	TR-R Fuse Rating	FLA	TR-R Fuse Rating	FLA	TR-R Fuse Rating
3	7.2	9	3.6	4-1/2	2.9	4
5	12	15	6	8	4.8	6
7.5	18	25	9	12	7.2	9
9	22	30	11	15	9	12
15	36	45	18	25	14	20
30	72	90	36	45	29	35
45	108	150	54	70	43	60
75	180	225	90	125	72	90
100	241	300	120	150	96	125
112.5	271	350	135	175	108	150
150	361	450	180	225	144	200
225	541	600	371	350	217	300
300	722	-	361	450	289	350
500	1203	-	601	-	481	600

* Where fuse sizes do not correspond to a standard ampere rating, the next higher standard rating shall be permitted.

Fusing for Three Phase Transformers - Primary and Secondary Protection

Transformer (kVA)	Primary Fuse Series and Ratings					Secondary Series and Ratings			
	240 V Primary					120 V Secondary		208 V Secondary	
	FLA	AJT/A2D-R	A4BT	A4BY	A4BQ	FLA	Fuse Rating	FLA	Fuse Rating
3	7.2	15	-	-	-	14	20	8	12
5	12	25	-	-	-	24	30	14	17-1/2
7.5	18	40	-	-	-	36	45	21	30
9	22	45	-	-	-	43	60	25	35
15	36	60	-	-	-	72	100	42	60
30	72	150	-	-	-	145	200	83	110
45	108	225	-	-	-	217	300	125	175
75	180	400	-	-	-	361	450	208	300
100	241	450	-	-	-	482	600	278	350
112.5	271	500	-	-	-	542	700	313	400
150	361	600	-	-	-	723	900	417	600
225	541	-	800	900	1200	1084	1350	625	800
300	722	-	1200	1200	1600	1445	1800	834	1200
500	1203	-	1800	2000	2500	2408	2500	1390	1600

Transformer (kVA)	Primary Fuse Series and Ratings					Secondary Fuse Ratings					
	480 V Primary					120 V Secondary		208 V Secondary		240 V Secondary	
	FLA	AJT/A6D-R	A4BT	A4BY	A4BQ	FLA	Fuse Rating	FLA	Fuse Rating	FLA	Fuse Rating
3	3.6	6	-	-	-	14	20	8	12	7	9
5	6	12	-	-	-	24	30	14	17-1/2	12	15
7.5	9	15	-	-	-	36	45	21	30	18	25
9	11	25	-	-	-	43	60	25	35	22	30
15	18	35	-	-	-	72	100	42	60	36	45
30	36	60	-	-	-	145	200	83	110	72	100
45	54	100	-	-	-	217	300	125	175	108	150
75	90	175	-	-	-	361	450	208	300	181	250
100	120	225	-	-	-	482	600	278	350	241	350
112.5	135	300	-	-	-	542	700	313	400	271	350
150	180	400	-	-	-	723	900	417	600	361	500
225	371	500	-	-	-	1084	1350	625	800	542	700
300	361	600	-	-	-	1445	1800	834	1200	723	1000
500	601	-	1000	1000	1200	2408	2500	1390	1600	1204	1600
750	902	-	1400	1600	2000	3613	4000	2084	2500	1806	2000
1000	1203	-	1800	2000	2500	4817	5000	2779	3000	2408	2500

Transformer (kVA)	Primary Fuse Series and Ratings					Secondary Fuse Ratings					
	600 V Primary					120 V Secondary		208 V Secondary		240 V Secondary	
	FLA	AJT/A6D-R	A4BT	A4BY	A4BQ	FLA	Fuse Rating	FLA	Fuse Rating	FLA	Fuse Rating
3	2.9	5	-	-	-	14	20	8	12	7	9
5	4.8	10	-	-	-	24	30	14	17-1/2	12	15
7.5	7.2	15	-	-	-	36	45	21	30	18	25
9	9	17-1/2	-	-	-	43	60	25	35	22	30
15	14	25	-	-	-	72	100	42	60	36	45
30	29	45	-	-	-	145	200	83	110	72	100
45	43	80	-	-	-	217	300	125	175	108	150
75	72	150	-	-	-	361	450	208	300	181	250
100	96	200	-	-	-	482	600	278	350	241	350
112.5	108	225	-	-	-	542	700	313	400	271	350
150	144	300	-	-	-	723	900	417	600	361	500
225	217	450	-	-	-	1084	1350	625	800	542	700
300	289	500	-	-	-	1445	1800	834	1200	723	1000
500	481	-	700	900	1000	2408	2500	1390	1600	1204	1600
750	722	-	1200	1400	1600	3613	4000	2084	2500	1806	2000
1000	962	-	1600	1800	2000	4817	5000	2779	3000	2408	2500

Control circuit transformers used as part of a motor control circuit are to be protected as outlined in Tables 1 & 2 with one important exception. Primary fuses may be sized up to 500% of transformer rated primary current if the rated primary current is less than 2 amperes.

When a control circuit transformer is energized, the typical magnetizing inrush will be 25-40 times rated primary full load current (FLA) for the first 1/2 cycle and dissipates to rated current in a few cycles. Fuses must be sized so they do not open during

this inrush. We recommend that fuses be selected to withstand 40 x FLA for .01 sec. and to stay within the NEC guidelines specified above.

For example: 300VA Transformer, 600V primary.

$$I_{pri} = \frac{\text{Transformer VA}}{\text{Primary V}} = \frac{300}{600} = 1/2A = \text{FLA}$$

The fuse time-current curve must lie to the right of the point 40 x (1/2A) = 20A @ .01 sec.

Secondary fuses are still sized at 125% of the secondary FLA.

Recommended Primary Fuses for Single Phase Control Transformers

Trans VA	600 Volt Primary						480 Volt Primary					
	FLA	ATQR	ATMR	A6D-R+	AJT+	TRS-R	FLA	ATQR	ATMR	A6D-R+	AJT+	TRS-R
25	.042	1/10	2/10	2/10	-	1/10	.052	1/10	1/4	1/4	-	1/10
50	.083	1/4	3/10*	4/10	-	2/10	.104	1/4	1/2*	1/2	-	2/10
75	.125	1/4	1/2*	6/10	-	2/10	.156	3/10	3/4*	6/10	-	2/10
100	.167	3/10	3/4*	8/10	-	3/10	.208	4/10	1	1	1	3/10
130	.22	4/10	1	1	1	4/10	.27	1/2	1	1	1-1/2	4/10
150	.25	1/2	1*	1-1/4	1	4/10	.313	1/2	1-1/2	1-4/10	1-1/2	4/10
200	.33	1/2	1-1/2	1-6/10	1-1/2	6/10	.417	6/10	2	2	2	6/10
250	.42	6/10	2	2	2	6/10	.52	8/10	2	2-1/2	2-1/2	6/10
300	.50	1	2	2-1/2	2	8/10	.62	1-1/2	3	3	3	8/10
350	.583	1-1/4	2	2-8/10	2	1	.73	1-1/2	3-1/2	3-1/2	3-1/2	1
500	.833	1-1/2	4	4	4	1-1/4	1.04	2	5	4	4	1-4/10
750	1.25	2-1/2	6	4	4	1-6/10	1.56	3*	7	5	5	2
1000	1.67	3	8	5	5	2-1/4	2.08	4+	-	5+	5+	3
1500	2.5	5+	-	6+	6+	4	3.125	7+	-	6-1/4+	6-1/4+	4
2000	3.33	8+	-	8+	8+	5	4.17	10+	-	7+	7+	5
3000	5.00	12+	-	12+	12+*	8	6.25	15+*	-	15+*	15+	8
5000	8.33	20+*	-	20+*	20+**	12+	10.4	-	-	25+*	25+*	15+
7500	12.5	30+*	-	30+*	30+**	17-1/2+	15.6	-	-	35+**	35+**	20+
10000	16.7	-	-	40+*	40+**	25+	20.8	-	-	50+**	50+**	30+
		240 Volt Primary					120 Volt Primary					
25	.104	2/10	1/2	1/2	-	2/10	.21	4/10	1	1	1	3/10
50	.21	4/10	1	1	1	3/10	.42	6/10	2	2	2	6/10
75	.31	1/2	1-1/2	1-4/10	1-1/2	4/10	.6	1	3	3	3	8/10
100	.42	6/10	2	2	2	6/10	.83	1-1/2	4	4	4	1
130	.54	1	2-1/2	2-1/2	2-1/2	8/10	1.08	2-1/2	5	4	4	1-6/10
150	.625	1	3	3	3	8/10	1.25	2-1/2	6	4	4	1-6/10
200	.83	1-1/2	4	3-1/2	3-1/2	1	1.67	3*	8	5	5	2-1/4
250	1.04	2	5	4	4	1-4/10	2.08	4+	-	5+	5+	2-8/10
300	1.25	2-1/2	6	4	4	1-6/10	2.5	5+	-	6+	6+	3-2/10
350	1.46	3*	7	5	5	2	2.92	7+	-	6+	6+	4
500	2.08	4+	-	5+	5+	2-8/10	4.17	10+	-	10+	6	5-6/10
750	3.13	7+	-	6-1/4+	6-1/4+	4	6.25	15+*	-	15+**	15+	8
1000	4.2	10+	-	7	7	5-6/10	8.33	20+*	-	20+**	20+*	12+
1500	6.25	15+	-	15+	15+	8	12.5	30+*	-	30+	30+	15
2000	8.3	20+*	-	20+**	20+**	12	16.7	-	-	40+**	40+	25+
3000	12.5	30+*	-	30+**	30+**	15	25	-	-	60+**	60+*	35+
5000	20.8	-	-	50+**	50+*	25	41.7	-	-	100+**	100+**	60+
7500	31.3	-	-	70+**	70+**	40+	62.5	-	-	150+**	150+**	90+
10000	41.7	-	-	100+**	100+**	60+	83.3	-	-	200+**	200+**	125+

The above fuses will withstand 40 x FLA for .01 second except where noted. + Secondary fusing required.

* Fuse will withstand 30 x FLA for .01 second.
** Fuse will withstand 35 x FLA for .01 second.

3 Phase 2400 Volt Typical Primary Fuse Sizing Chart										
Trans- former Rating kVA ¹	Full Load Amperes	2" Ferrule mounting			3" Ferrule mounting (single and double)			Bolt on		Clip Lock
		9F60 EJ "C"	9F60 EJO "C"	A055F	9F60 EJ "D"	9F60 EJO "D"	A055F	A055B	A055C	
9	2.2	9F60CCB005 *	9F60DJB005	A055F1C0R0-5E	-	-	-	-	-	
15	3.6	9F60CCB010 *	9F60DJB010	A055F1C0R0-7E	-	-	-	-	-	
30	7.2	9F60CCB020 *	9F60DJB020	A055F1C0R0-10E	-	-	A055F1D0R0-10E	A055B1DAR0-10E	A055C1D0R0-10E	
45	11	9F60CCB025 *	9F60DJB025	A055F1C0R0-15E	-	-	A055F1D0R0-15E	A055B1DAR0-15E	A055C1D0R0-15E	
75	18	-	-	A055F1C0R0-25E	9F60ECB030	9F60FJB030	A055F1D0R0-25E	A055B1DAR0-25E	A055C1D0R0-25E	
112.5	27	-	-	A055F1C0R0-40E	9F60ECB050	9F60FJB050	A055F1D0R0-40E	A055B1DAR0-40E	A055C1D0R0-40E	
150	36	-	-	A055F1C0R0-50E	9F60ECB065	9F60FJB065	A055F1D0R0-50E	A055B1DAR0-50E	A055C1D0R0-50E	
225	54	-	-	-	9F60ECB100	9F60FJB100	A055F1D0R0-80E	A055B1DAR0-80E	A055C1D0R0-80E	
300	72	-	-	-	9F60GCB125	9F60HJB125	A055F1D0R0-100E	A055B1DAR0-100E	A055C1D0R0-100E	
500	120	-	-	-	9F60GCB200	9F60HJB200	A055F1D0R0-200E	A055B1DAR0-200E	A055C1D0R0-200E	
750	181	-	-	-	-	-	A055F2D0R0-250E	A055B2DAR0-250E	A055C1D0R0-250E	
1000	241	-	-	-	-	-	A055F2D0R0-400E	A055B2DAR0-400E	A055C1D0R0-400E	
1500	361	-	-	-	-	-	-	A055B2DAR0-500E	A055C2D0R0-500E	
2000	482	-	-	-	-	-	-	A055B2DAR0-600E	A055C2D0R0-600E	

Fuses will carry transformer magnetizing inrush current of 25 times full load amperes for .01 second and 12 times full load current for .1 second. EJO fuses can be used outdoors without an enclosure. ¹The self cooled rating of the transformer. If using a force cooled transformer rating, the fuse E rating must be sized ≥ 1.25 times the force cooled transformer FLA. *Use CEB in place of CCB for 9" clip center fuses.

3 Phase 4160 Volt Typical Primary Fuse Sizing Chart											
Trans- former Rating kVA ¹	Full Load Amp- eres	2" Ferrule mounting				3" Ferrule mounting (single and double)			Bolt on		Clip Lock
		9F60 EJ "C"	9F60 EJO "C"	9F62 EJO "C"	A055F	9F60 EJO "D"	9F62 EJO "D"	A055F	9F62 EJO "DDDD"	A055B	A055C
9	1.3	9F60CED005	9F60DJD005	-	A055F1C0R0-5E	-	-	-	-	-	-
15	2.1	9F60CED007	9F60DJD007	-	A055F1C0R0-5E	-	-	-	-	-	-
30	4.2	9F60CED015	9F60DJD015	-	A055F1C0R0-7E	-	-	A055F1D0R0-10E	-	A055B1DAR0-10E	A055C1D0R0-10E
45	6.3	9F60CED015	9F60DJD015	-	A055F1C0R0-10E	-	-	A055F1D0R0-10E	-	A055B1DAR0-10E	A055C1D0R0-10E
75	10	9F60CED025	9F60DJD025	9F62HCB025	A055F1C0R0-15E	-	-	A055F1D0R0-15E	-	A055B1DAR0-15E	A055C1D0R0-15E
112.5	16	-	-	9F62HCB030	A055F1C0R0-20E	9F60FJD040	-	A055F1D0R0-20E	-	A055B1DAR0-20E	A055C1D0R0-20E
150	21	-	-	9F62HCB040	A055F1C0R0-30E	9F60FJD040	-	A055F1D0R0-30E	-	A055B1DAR0-30E	A055C1D0R0-30E
225	31	-	-	9F62HCB050	A055F1C0R0-40E	9F60FJD065	-	A055F1D0R0-40E	-	A055B1DAR0-40E	A055C1D0R0-40E
300	42	-	-	-	A055F1C0R0-65E	9F60FJD080	9F62DCB080	A055F1D0R0-65E	-	A055B1DAR0-65E	A055C1D0R0-65E
500	69	-	-	-	-	9F60FJD100	9F62DCB100	A055F1D0R0-100E	-	A055B1DAR0-100E	A055C1D0R0-100E
750	104	-	-	-	-	9F60HJD150	9F62DCB150	A055F1D0R0-150E	-	A055B1DAR0-150E	A055C1D0R0-150E
1000	139	-	-	-	-	9F60HJD200	9F62DCB200	A055F1D0R0-200E	-	A055B1DAR0-200E	A055C1D0R0-200E
1500	208	-	-	-	-	-	9F62FCB300	A055F2D0R0-300E	-	A055B2DAR0-300E	A055C1D0R0-300E
2000	278	-	-	-	-	-	9F62FCB350	A055F2D0R0-400E	-	A055B2DAR0-400E	A055C1D0R0-400E
2500	347	-	-	-	-	-	-	-	9F62KCB500	A055B2D0R0-500E	A055C2D0R0-500E
3000	417	-	-	-	-	-	-	-	9F62KCB600	A055B2D0R0-600E	A055C2D0R0-600E
3750	520	-	-	-	-	-	-	-	9F62KCB700	A055B3D0R0-750E	-
4000	556	-	-	-	-	-	-	-	9F62KCB700	A055B3D0R0-750E	-
4500	625	-	-	-	-	-	-	-	9F62KCB800	A055B3D0R0-900E	-
5000	695	-	-	-	-	-	-	-	9F62KCB900	A055B3D0R0-900E	-

Fuses will carry transformer magnetizing inrush current of 25 times full load amperes for .01 second and 12 times full load current for .1 second. EJO fuses can be used outdoors without an enclosure. ¹The self cooled rating of the transformer. If using a force cooled transformer rating, the fuse E rating must be sized ≥ 1.25 times the force cooled transformer FLA.

EXAMPLES

1. A new installation has a 300kVA transformer with 4160V primary. It is not fully loaded. What is the typical primary fuse recommended?
2. What is the normal fuse size recommended for a 1500kVA transformer with 12,470V primary?

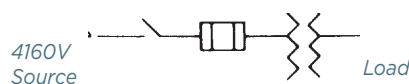

A 65 rating (Mersen A055F1D0R0-65E or equivalent) is correct. Lower ratings may open when transformer is energized.

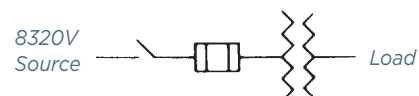

For this application use a 100E rating A155F2D0R0-100E or equivalent which will allow normal overload operations of transformer up to 133% of rating.

3 Phase 4800 Volt Typical Primary Fuse Sizing Chart											
Transformer Rating kVA ¹	Full Load Amperes	2" Ferrule mounting				3" Ferrule mounting (single and double)			Bolt on		Clip Lock
		9F60 EJ "C"	9F60 EJO "C"	9F62 EJO "C"	A055F	9F60 EJO "D"	9F62 EJO "D"	A055F	9F62 EJO "DDDD"	A055B	A055C
9	1.1	9F60CED005	9F60DJ005	-	-	-	-	-	-	-	-
15	1.8	9F60CED005	9F60DJ005	-	A055F1C0R0-5E	-	-	-	-	-	-
30	3.6	9F60CED010	9F60DJ010	-	A055F1C0R0-7E	-	-	-	-	-	-
45	5.4	9F60CED015	9F60DJ015	-	A055F1C0R0-10E	-	-	A055F1D0R0-10E	-	A055B1DAR0-10E	A055C1D0R0-10E
75	9.0	9F60CED020	9F60DJ020	9F62HCB025	A055F1C0R0-15E	-	-	A055F1D0R0-15E	-	A055B1DAR0-15E	A055C1D0R0-15E
112.5	14	9F60CED030	9F60DJ030	9F62HCB030	A055F1C0R0-20E	-	-	A055F1D0R0-20E	-	A055B1DAR0-20E	A055C1D0R0-20E
150	18	-	-	9F62HCB040	A055F1C0R0-25E	9F60FJD040	-	A055F1D0R0-25E	-	A055B1DAR0-25E	A055C1D0R0-25E
225	27	-	-	9F62HCB050	A055F1C0R0-40E	9F60FJD065	-	A055F1D0R0-40E	-	A055B1DAR0-40E	A055C1D0R0-40E
300	36	-	-	9F62HCB065	A055F1C0R0-50E	9F60FJD065	-	A055F1D0R0-50E	-	A055B1DAR0-50E	A055C1D0R0-50E
500	60	-	-	-	-	9F60FJD100	9F62DCB080	A055F1D0R0-80E	-	A055B1DAR0-80E	A055C1D0R0-80E
750	90	-	-	-	-	9F60HJD125	9F62DCB125	A055F1D0R0-125E	-	A055B1DAR0-125E	A055C1D0R0-125E
1000	120	-	-	-	-	9F60HJD150	9F62DCB150	A055F1D0R0-200E	-	A055B1DAR0-200E	A055C1D0R0-200E
1500	181	-	-	-	-	-	9F62FCB250	A055F2D0R0-250E	-	A055B2DAR0-250E	A055C1D0R0-250E
2000	241	-	-	-	-	-	9F62FCB350	A055F2D0R0-300E	-	A055B2DAR0-400E	A055C1D0R0-400E
2500	301	-	-	-	-	-	9F62FCB400	A055F2D0R0-400E	-	A055B2DAR0-400E	A055C1D0R0-400E
3000	361	-	-	-	-	-	-	-	9F62KCB500	A055B2D0R0-500E	A055C2D0R0-500E
3750	421	-	-	-	-	-	-	-	9F62KCB600	A055B2D0R0-600E	A055C2D0R0-600E
4000	482	-	-	-	-	-	-	-	9F62KCB700	A055B2D0R0-600E	A055C2D0R0-600E
4500	542	-	-	-	-	-	-	-	9F62KCB700	A055B3D0R0-750E	-
5000	602	-	-	-	-	-	-	-	9F62KCB800	A055B3D0R0-900E	-
5500	662	-	-	-	-	-	-	-	9F62KCB900	A055B3D0R0-900E	-
6000	723	-	-	-	-	-	-	-	9F62KCB900	A055B3D0R0-900E	-

Fuses will carry transformer magnetizing inrush current of 25 times full load amperes for .01 second and 12 times full load current for .1 second.
EJO fuses can be used outdoors without an enclosure.

¹ The self cooled rating of the transformer. If using a force cooled transformer rating, the fuse E rating must be sized ≥ 1.25 times the force cooled transformer FLA.

3 Phase 6900 Volt Typical Primary Fuse Sizing Chart							
Transformer Rating kVA ¹	Full Load Amperes	2" Ferrule mounting		3" Ferrule mounting (single and double)			Bolt on
		9F60 EJO "C"	9F62 EJO "C"	9F60 EJO "D"	9F62 EJO "D"	A825X	A072B
9	0.75	9F60DJE003	-	-	-	-	-
15	1.3	9F60DJE005	-	-	-	-	-
30	2.5	9F60DJE010	-	-	-	-	-
45	3.8	9F60DJE010	-	-	-	-	-
75	6.3	-	9F62HCC020	9F60FJE020	-	A825X10E-1	-
112.5	9.4	-	9F62HCC020	9F60FJE025	-	A825X15E-1	-
150	13	-	9F62HCC025	9F60FJE040	-	A825X20E-1	-
225	19	-	9F62HCC040	9F60FJE050	-	A825X25E-1	-
300	25	-	9F62HCC040	9F60FJE065	-	A825X40E-1	-
500	42	-	-	9F60FJE100	9F62DCC065	A825X65E-1	-
750	63	-	-	9F60HJE125	9F62DCC080	A825X80E-1	-
1000	84	-	-	9F60HJE150	9F62DCC150	A825X125E-1	-
1500	126	-	-	-	9F62FCC200	A825X200E-1	-
2000	168	-	-	-	9F62FCC250	-	A072B2D0R0-250E
2500	209	-	-	-	-	-	A072B2D0R0-300E
3000	251	-	-	-	-	-	A072B2D0R0-350E
3500	293	-	-	-	-	-	A072B2D0R0-400E

Fuses will carry transformer magnetizing inrush current of 25 times full load amperes for .01 second and 12 times full load current for .1 second.
EJO fuses can be used outdoors without an enclosure.

¹ The self cooled rating of the transformer. If using a force cooled transformer rating, the fuse E rating must be sized ≥ 1.25 times the force cooled transformer FLA.

MAXIMUM FUSE SIZE

The Code allows primary fuses to be sized at 250% of transformer primary current rating or next standard fuse rating. Sizing this large may not provide adequate protection. Maximum fuse size should be determined by making sure the fuse total clearing curve does not exceed transformer damage curve. The transformer manufacturer should be consulted to determine transformer overload and short circuit withstand capability.



3 Phase 7200 Volt Typical Primary Fuse Sizing Chart							
Transformer Rating kVA ¹	Full Load Amperes	2" Ferrule mounting		3" Ferrule mounting (single and double)			Bolt on A072B
		9F60 EJO "C"	9F62 EJO "C"	9F60 EJO "D"	9F62 EJO "D"	A825X	
9	0.72	9F60DJE003	-	-	-	-	-
15	1.2	9F60DJE005	-	-	-	-	-
30	2.4	9F60DJE010	-	-	-	-	-
45	3.6	9F60DJE010	-	-	-	-	-
75	6.0	-	-	9F60FJE020	-	-	-
112.5	9.0	-	9F62HCC020	9F60FJE025	-	-	-
150	12	-	9F62HCC020	9F60FJE040	-	A825X20E-1	-
225	18	-	9F62HCC040	9F60FJE050	-	A825X25E-1	-
300	24	-	9F62HCC040	9F60FJE065	-	A825X40E-1	-
500	40	-	9F62HCC050	9F60FJE100	-	A825X65E-1	-
750	60	-	-	9F60HJE125	9F62DCC080	A825X80E-1	-
1000	80	-	-	9F60HJE150	9F62DCC125	A825X125E-1	-
1500	120	-	-	9F60HJE200	9F62FCC200	A825X200E-1	-
2000	161	-	-	-	9F62FCC200	A825X200E-1	-
2500	201	-	-	-	9F62FCC250	-	A072B2D0R0-250E
3000	241	-	-	-	-	-	A072B2D0R0-300E
3500	281	-	-	-	-	-	A072B2D0R0-350E
4000	321	-	-	-	-	-	A072B2D0R0-400E

Fuses will carry transformer magnetizing inrush current of 25 times full load amperes for .01 second and 12 times full load current for .1 second
EJO fuses can be used outdoors without an enclosure

¹ The self cooled rating of the transformer. If using a force cooled transformer rating, the fuse E rating must be sized ≥ 1.25 times the force cooled transformer FLA.

3 Phase 12,000 Volt Typical Primary Fuse Sizing Chart											
Trans- former Rating kVA ¹	Full Load Amperes	2" Ferrule mounting				3" Ferrule mounting (single and double)			Bolt on		Clip Lock
		9F60 EJ "C"	9F60 EJO "C"	9F62 EJO "C"	A155F	9F60 EJO "D"	9F62 EJO "D"	A155F	9F62 EJO "DDDD"	A155B	A155C
9	0.43	9F60CJH002	9F60DMH002	-	-	-	-	-	-	-	-
15	0.72	9F60CJH003	9F60DMH003	-	-	-	-	-	-	-	-
30	1.4	9F60CJH005	9F60DMH005	-	-	-	-	-	-	-	-
45	2.2	9F60CJH007	9F60DMH007	-	A155F1C0R0-5E	-	-	-	-	-	-
75	3.6	9F60CJH010	9F60DMH010	-	A155F1C0R0-7E	-	-	-	-	-	-
112.5	5.4	-	-	9F62HDD020	A155F1C0R0-10E	9F60FMH020	-	A155F1D0R0-10E	-	A155B1D0R0-10E	A155C1D0R0-10E
150	7.2	-	-	9F62HDD020	A155F1C0R0-10E	9F60FMH025	-	A155F1D0R0-10E	-	A155B1D0R0-10E	A155C1D0R0-10E
225	10.8	-	-	9F62HDD020	A155F1C0R0-15E	9F60FMH030	-	A155F1D0R0-15E	-	A155B1D0R0-15E	A155C1D0R0-15E
300	14	-	-	9F62HDD025	A155F1C0R0-20E	9F60FMH040	-	A155F1D0R0-20E	-	A155B1D0R0-20E	A155C1D0R0-20E
500	24	-	-	-	-	9F60HMH065	-	A155F1D0R0-40E	-	A155B1D0R0-40E	A155C1D0R0-40E
750	36	-	-	-	-	9F60HMH100	9F62DDD065	A155F1D0R0-50E	-	A155B1D0R0-50E	A155C1D0R0-50E
1000	48	-	-	-	-	9F60HMH100	9F62DDD065	A155F1D0R0-65E*	-	A155B1D0R0-65E	A155C1D0R0-65E

Fuses will carry transformer magnetizing inrush current of 25 times full load amperes for .01 second and 12 times full load current for .1 second.
EJO fuses can be used outdoors without an enclosure.

¹ The self cooled rating of the transformer. If using a force cooled transformer rating, the fuse E rating must be sized ≥ 1.25 times the force cooled transformer FLA.

* Use F2 in place of F1 for double barrel fuses.

3 Phase 12,470 Volt Typical Primary Fuse Sizing Chart												
Trans- former Rating kVA ¹	Full Load Amp- eres	2" Ferrule mounting				3" Ferrule mounting (single and double)			9F62 EJO "DDDD"	Bolt on		Clip Lock
		9F60 E.J "C"	9F60 EJO "C"	9F62 EJO "C"	A155F	9F60 EJO "D"	9F62 EJO "D"	A155F		A155B	A155C	
30	1.4	9F60CJH005	9F60DMH005	-	-	-	-	-	-	-	-	
45	2.1	9F60CJH007	9F60DMH007	-	A155F1COR0-5E	-	-	-	-	-	-	
75	3.5	9F60CJH010	9F60DMH010	-	A155F1COR0-7E	-	-	-	-	-	-	
112.5	5.2	-	-	9F62HDD020	A155F1COR0-10E	9F60FMH020	-	A155F1DOR0-10E	-	A155B1DOR0-10E	A155C1DOR0-10E	
150	7.0	-	-	9F62HDD020	A155F1COR0-10E	9F60FMH020	-	A155F1DOR0-10E	-	A155B1DOR0-10E	A155C1DOR0-10E	
225	10	-	-	9F62HDD020	A155F1COR0-15E	9F60FMH025	-	A155F1DOR0-15E	-	A155B1DOR0-15E	A155C1DOR0-15E	
300	14	-	-	9F62HDD025	A155F1COR0-20E	9F60FMH040	-	A155F1DOR0-20E	-	A155B1DOR0-20E	A155C1DOR0-20E	
500	23	-	-	9F62HDD030	A155F1COR0-30E	9F60FMH050	-	A155F1DOR0-30E	-	A155B1DOR0-30E	A155C1DOR0-30E	
750	35	-	-	-	-	9F60HMH065	9F62DDD065	A155F1DOR0-50E	-	A155B1DOR0-50E	A155C1DOR0-50E	
1000	46	-	-	-	-	9F60HMH080	9F62DDD065	A155F1DOR0-65E*	-	A155B1DOR0-65E	A155C1DOR0-65E	
1500	70	-	-	-	-	-	9F62DDD100	A155F1DOR0-100E*	-	A155B1DOR0-100E	A155C1DOR0-100E	
2000	93	-	-	-	-	-	9F62FDD125	A155F2DOR0-125E	-	A155B2DOR0-125E	A155C2DOR0-125E	
2500	116	-	-	-	-	-	9F62FDD150	A155F2DOR0-150E	-	A155B2DOR0-150E	A155C2DOR0-150E	
3000	139	-	-	-	-	-	9F62FDD175	A155F2DOR0-175E	-	A155B2DOR0-200E	A155C2DOR0-200E	
3500	162	-	-	-	-	-	9F62FDD200	A155F2DOR0-200E	-	A155B2DOR0-200E	A155C2DOR0-200E	
4000	185	-	-	-	-	-	-	-	-	A155B3DOR0-250E	A155C3DOR0-250E	
4500	209	-	-	-	-	-	-	-	-	A155B3DOR0-250E	A155C3DOR0-250E	
5000	232	-	-	-	-	-	-	-	9F62KED300	A155B3DOR0-300E	A155C3DOR0-300E	
5500	255	-	-	-	-	-	-	-	9F62KED300	A155B3DOR0-300E	A155C3DOR0-300E	

Fuses will carry transformer magnetizing inrush current of 25 times full load amperes for .01 second and 12 times full load current for .1 second.
EJO fuses can be used outdoors without an enclosure.

¹ The self cooled rating of the transformer. If using a force cooled transformer rating, the fuse E rating must be sized ≥ 1.25 times the force cooled transformer FLA.

* Use F2 in place of F1 for double barrel fuses.

3 Phase 13,200 Volt Typical Primary Fuse Sizing Chart												
Trans- former Rating kVA ¹	Full Load Amp- eres	2" Ferrule mounting				3" Ferrule mounting (single and double)			9F62 EJO "DDDD"	Bolt on		Clip Lock
		9F60 E.J "C"	9F60 EJO "C"	9F62 EJO "C"	A155F	9F60 EJO "D"	9F62 EJO "D"	A155F		A155B	A155C	
9	0.4	9F60CJH002	9F60DMH002	-	-	-	-	-	-	-	-	
15	0.7	9F60CJH003	9F60DMH003	-	-	-	-	-	-	-	-	
30	1.3	9F60CJH005	9F60DMH005	-	-	-	-	-	-	-	-	
45	2.0	9F60CJH007	9F60DMH007	-	A155F1COR0-5E	-	-	-	-	-	-	
75	3.3	9F60CJH010	9F60DMH010	-	A155F1COR0-7E	-	-	-	-	-	-	
112.5	4.9	-	-	-	A155F1COR0-10E	9F60FMH015	-	A155F1DOR0-10E	-	A155B1DOR0-10E	A155C1DOR0-10E	
150	6.6	-	-	-	A155F1COR0-10E	9F60FMH020	-	A155F1DOR0-10E	-	A155B1DOR0-10E	A155C1DOR0-10E	
225	10	-	-	9F62HDD020	A155F1COR0-15E	9F60FMH030	-	A155F1DOR0-15E	-	A155B1DOR0-15E	A155C1DOR0-15E	
300	13	-	-	9F62HDD025	A155F1COR0-20E	9F60FMH040	-	A155F1DOR0-20E	-	A155B1DOR0-20E	A155C1DOR0-20E	
500	22	-	-	9F62HDD030	A155F1COR0-30E	9F60HMH065	-	A155F1DOR0-30E	-	A155B1DOR0-30E	A155C1DOR0-30E	
750	33	-	-	-	-	9F60HMH080	9F62DDD050	A155F1DOR0-50E	-	A155B1DOR0-50E	A155C1DOR0-50E	
1000	44	-	-	-	-	9F60HMH100	9F62DDD065	A155F1DOR0-65E*	-	A155B1DOR0-65E	A155C1DOR0-65E	
1500	66	-	-	-	-	-	9F62DDD100	A155F1DOR0-100E*	-	A155B1DOR0-100E	A155C1DOR0-100E	
2000	88	-	-	-	-	-	9F62FDD125	A155F2DOR0-125E	-	A155B2DOR0-125E	A155C2DOR0-125E	
2500	109	-	-	-	-	-	9F62FDD150	A155F2DOR0-150E	-	A155B2DOR0-150E	A155C2DOR0-150E	
3000	131	-	-	-	-	-	9F62FDD175	A155F2DOR0-200E	-	A155B2DOR0-200E	A155C2DOR0-200E	
3500	153	-	-	-	-	-	9F62FDD200	A155F2DOR0-200E	-	A155B2DOR0-200E	A155C2DOR0-200E	
4000	175	-	-	-	-	-	-	-	-	A155B3DOR0-250E	A155C3DOR0-250E	
4500	197	-	-	-	-	-	-	-	-	A155B3DOR0-250E	A155C3DOR0-250E	
5000	219	-	-	-	-	-	-	-	9F62KED300	A155B3DOR0-300E	A155C3DOR0-300E	
5500	241	-	-	-	-	-	-	-	9C62KED300	A155B3DOR0-300E	A155C3DOR0-300E	

Fuses will carry transformer magnetizing inrush current of 25 times full load amperes for .01 second and 12 times full load current for .1 second.
EJO fuses can be used outdoors without an enclosure.

¹ The self cooled rating of the transformer. If using a force cooled transformer rating, the fuse E rating must be sized ≥ 1.25 times the force cooled transformer FLA.

* Use F2 in place of F1 for double barrel fuses.

Primary Fuses for MV 3-PHASE POWER TRANSFORMERS

APPLICATION
INFORMATION

3 Phase 13,800 Volt Typical Primary Fuse Sizing Chart											
Trans- former Rating kVA ¹	Full Load Amp- eres	2" Ferrule mounting				3" Ferrule mounting (single and double)			Bolt on		Clip Lock
		9F60 EJ "C"	9F60 EJO "C"	9F62 EJO "C"	A155F	9F60 EJO "D"	9F62 EJO "D"	A155F	9F62 EJO "DDDD"	A155B	A155C
30	1	9F60CJH005	9F60DMH005	-	-	-	-	-	-	-	-
45	2	9F60CJH007	9F60DMH007	-	A155F1C0R0-5E	-	-	-	-	-	-
75	3	9F60CJH010	9F60DMH010	-	A155F1C0R0-7E	-	-	-	-	-	-
112.5	5	-	-	-	A155F1C0R0-10E	9F60FMH015	-	A155F1D0R0-10E	-	A155B1D0R0-10E	A155C1D0R0-10E
150	6	-	-	-	A155F1C0R0-10E	9F60FMH020	-	A155F1D0R0-10E	-	A155B1D0R0-10E	A155C1D0R0-10E
225	9	-	-	9F62HDD020	A155F1C0R0-15E	9F60FMH030	-	A155F1D0R0-15E	-	A155B1D0R0-15E	A155C1D0R0-15E
300	13	-	-	9F62HDD025	A155F1C0R0-20E	9F60FMH030	-	A155F1D0R0-20E	-	A155B1D0R0-20E	A155C1D0R0-20E
500	21	-	-	9F62HDD030	A155F1C0R0-30E	9F60FMH040	-	A155F1D0R0-30E	-	A155B1D0R0-30E	A155C1D0R0-30E
750	31	-	-	-	-	9F60HMH065	9F62DDD050	A155F1D0R0-50E	-	A155B1D0R0-50E	A155C1D0R0-50E
1000	42	-	-	-	-	9F60HMH080	9F62DDD065	A155F1D0R0-65E*	-	A155B1D0R0-65E	A155C1D0R0-65E
1500	63	-	-	-	-	9F60HMH100	9F62DDD100	A155F1D0R0-100E*	-	A155B1D0R0-100E	A155C1D0R0-100E
2000	84	-	-	-	-	-	9F62FDD125	A155F2D0R0-125E	-	A155B2D0R0-125E	A155C2D0R0-125E
2500	105	-	-	-	-	-	9F62FDD150	A155F2D0R0-150E	-	A155B2D0R0-150E	A155C2D0R0-150E
3000	126	-	-	-	-	-	9F62FDD200	A155F2D0R0-200E	-	A155B2D0R0-200E	A155C2D0R0-200E
3500	147	-	-	-	-	-	9F62FDD200	A155F2D0R0-200E	-	A155B2D0R0-200E	A155C2D0R0-200E
4000	168	-	-	-	-	-	-	-	-	A155B3D0R0-250E	A155C3D0R0-250E
4500	188	-	-	-	-	-	-	-	-	A155B3D0R0-250E	A155C3D0R0-250E
5000	209	-	-	-	-	-	-	-	-	A155B3D0R0-300E	A155C3D0R0-300E
5500	230	-	-	-	-	-	-	-	9F62KED300	A155B3D0R0-300E	A155C3D0R0-300E
6000	251	-	-	-	-	-	-	-	9F62KED300	A155B3D0R0-300E	A155C3D0R0-300E

Fuses will carry transformer magnetizing inrush current of 25 times full load amperes for .01 second and 12 times full load current for .1 second.
EJO fuses can be used outdoors without an enclosure.

¹ The self cooled rating of the transformer. If using a force cooled transformer rating, the fuse E rating must be sized ≥ 1.25 times the force cooled transformer FLA.

* Use F2 in place of F1 for double barrel fuses.

3 Phase 14,400 Volt Typical Primary Fuse Sizing Chart											
Trans- former Rating kVA ¹	Full Load Amp- eres	2" Ferrule mounting				3" Ferrule mounting (single and double)			Bolt on		Clip Lock
		9F60 EJ "C"	9F60 EJO "C"	9F62 EJO "C"	A155F	9F60 EJO "D"	9F62 EJO "D"	A155F	9F62 EJO "DDDD"	A155B	A155C
9	0.4	9F60DMH002	9F60CJH002	-	-	-	-	-	-	-	-
15	0.6	9F60DMH003	9F60CJH003	-	-	-	-	-	-	-	-
30	1.2	9F60DMH005	9F60CJH005	-	-	-	-	-	-	-	-
45	1.8	9F60DMH007	9F60CJH007	-	A155F1C0R0-5E	-	-	-	-	-	-
75	3.0	9F60DMH010	9F60CJH010	-	A155F1C0R0-7E	-	-	-	-	-	-
112.5	5	-	-	-	A155F1C0R0-10E	9F60FMH015	-	A155F1D0R0-10E	-	A155B1D0R0-10E	A155C1D0R0-10E
150	6	-	-	-	A155F1C0R0-10E	9F60FMH020	-	A155F1D0R0-10E	-	A155B1D0R0-10E	A155C1D0R0-10E
225	9	-	-	9F62HDD020	A155F1C0R0-15E	9F60FMH030	-	A155F1D0R0-15E	-	A155B1D0R0-15E	A155C1D0R0-15E
300	12	-	-	9F62HDD020	A155F1C0R0-20E	9F60FMH040	-	A155F1D0R0-20E	-	A155B1D0R0-20E	A155C1D0R0-20E
500	20	-	-	9F62HDD030	A155F1C0R0-30E	9F60FMH050	-	A155F1D0R0-30E	-	A155B1D0R0-30E	A155C1D0R0-30E
750	30	-	-	-	-	9F60FMH080	9F62DDD050	A155F1D0R0-40E	-	A155B1D0R0-50E	A155C1D0R0-50E
1000	40	-	-	-	-	9F60FMH100	9F62DDD065	A155F1D0R0-65E*	-	A155B1D0R0-65E	A155C1D0R0-65E
1500	60	-	-	-	-	-	9F62DDD080	A155F1D0R0-80E*	-	A155B1D0R0-100E	A155C1D0R0-100E
2000	80	-	-	-	-	-	9F62FDD125	A155F2D0R0-125E	-	A155B2D0R0-125E	A155C2D0R0-125E
2500	100	-	-	-	-	-	9F62FDD150	A155F2D0R0-150E	-	A155B2D0R0-150E	A155C2D0R0-150E
3000	120	-	-	-	-	-	9F62FDD175	A155F2D0R0-175E	-	A155B2D0R0-150E	A155C2D0R0-150E
3500	140	-	-	-	-	-	9F62FDD200	A155F2D0R0-200E	-	A155B2D0R0-200E	A155C2D0R0-200E
4000	161	-	-	-	-	-	-	-	-	A155B3D0R0-250E	A155C3D0R0-250E
4500	181	-	-	-	-	-	-	-	-	A155B3D0R0-250E	A155C3D0R0-250E
5000	201	-	-	-	-	-	-	-	-	A155B3D0R0-300E	A155C3D0R0-300E
5500	221	-	-	-	-	-	-	-	9F62KED300	A155B3D0R0-300E	A155C3D0R0-300E
6000	241	-	-	-	-	-	-	-	9F62KED300	A155B3D0R0-300E	A155C3D0R0-300E

Fuses will carry transformer magnetizing inrush current of 25 times full load amperes for .01 second and 12 times full load current for .1 second.
EJO fuses can be used outdoors without an enclosure.

¹ The self cooled rating of the transformer. If using a force cooled transformer rating, the fuse E rating must be sized ≥ 1.25 times the force cooled transformer FLA.

* use F2 in place of F1 for double barrel fuses.

AP

3 Phase 22,000 Volt Typical Primary Fuse Sizing Chart			
Transformer Rating kVA ¹	Full Load Amperes	2" Ferrule mounting	3" Ferrule mounting (single and double)
		9F60 EJO "C"	9F60 EJO "D"
30	0.79	9F60DNJ003	-
45	1.18	9F60DNJ005	-
75	1.97	9F60DNJ007	-
112.5	2.95	9F60DNJ010	-
150	3.93	9F60DNJ010	-
225	5.9	-	9F60FNJ020
300	7.84	-	9F60FNJ020
500	13.1	-	9F60FNJ030
750	19.7	-	9F60FNJ050
1000	26.2	-	9F60HNJ065
1500	39.4	-	9F60HNJ080
2000	52.4	-	9F60HNJ100

Fuses will carry transformer magnetizing inrush current of 25 times full load amperes for .01 second and 12 times full load current for .1 second.
EJO fuses can be used outdoors without an enclosure.

¹ The self cooled rating of the transformer. If using a force cooled transformer rating, the fuse E rating must be sized ≥ 1.25 times the force cooled transformer FLA.

3 Phase 33,000 Volt Typical Primary Fuse Sizing Chart			
Transformer Rating kVA ¹	Full Load Amperes	3" Ferrule mounting (single and double)	
		9F60 EJO "D" with indicator	9F60 EJO "D" without indicator
45	0.79	9F60FPK002	9F60FPT002
75	1.31	9F60FPK005	9F60FPT005
112.5	1.98	9F60FPK005	9F60FPT005
150	2.62	9F60FPK007	9F60FPT007
225	3.96	9F60FPK010	9F60FPT010
300	5.26	9F60FPK015	9F60FPT015
500	8.71	9F60FPK025	9F60FPT025
750	13.1	9F60FPK030	9F60FPT030
1000	17.5	9F60FPK040	9F60FPT040
1500	26.2	9F60HPK065	9F60HPT065
2000	35	9F60HPK065	9F60HPT065
2500	43.7	9F60HPK080	9F60HPT080

Fuses will carry transformer magnetizing inrush current of 25 times full load amperes for .01 second and 12 times full load current for .1 second.
EJO fuses can be used outdoors without an enclosure.

¹ The self cooled rating of the transformer. If using a force cooled transformer rating, the fuse E rating must be sized ≥ 1.25 times the force cooled transformer FLA.

Current limitation is one of the important benefits provided by modern fuses. Current-limiting fuses are capable of isolating a faulted circuit before the fault current has sufficient time to reach its maximum value. This current-limiting action provides several benefits:

- It limits thermal and mechanical stresses created by the fault currents.
- It reduces the magnitude and duration of the system voltage drop caused by fault currents.
- Current-limiting fuses can be precisely and easily coordinated under even short circuit conditions to minimize unnecessary service interruption.

Peak let-thru current (I_p) and I^2t are two measures of the degree of current limitation provided by a fuse. Maximum allowable I_p and I^2t values are specified in UL standards for all UL listed current-limiting fuses, and are available on all semiconductor fuses.

LET-THRU CURRENT

Let-thru current is that current passed by a fuse while the fuse is interrupting a fault within the fuse's current-limiting range. Figure 1 illustrates this. Let-thru current is expressed as a peak instantaneous value (I_p).

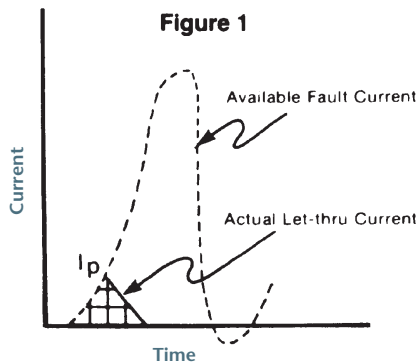

I_p

I_p data is generally presented in the form of a graph. Let's review the key information provided by a peak let-thru graph. Figure 2 shows the important components.

- (1) The X-axis is labeled "Available Fault Current" in RMS symmetrical amperes.
- (2) The Y-axis is labeled as "Instantaneous Peak Let-Thru Current" in amperes.

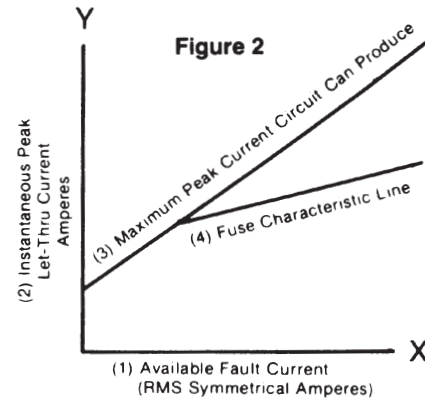

- (3) The line labeled "Maximum Peak Current Circuit Can Produce" gives the worst case peak current possible with no fuse in the circuit.
- (4) The fuse characteristic line is a plot of the peak let-thru currents which are passed by a given fuse at various available fault currents.

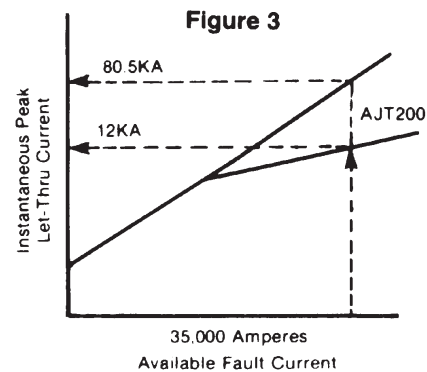
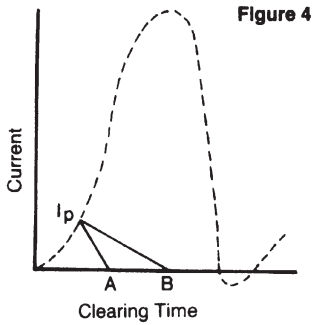

Figure 3 illustrates the use of the peak let-thru current graph. Assume that a 200 ampere Class J fuse (#AJT200) is to be applied where the available fault current is 35,000 amperes RMS. The graph shows that with 35,000 amperes RMS available, the peak available current is 80,500 amperes ($35,000 \times 2.3$) and that the fuse will limit the peak let-thru current to 12,000 amperes.

Why is the peak available current 2.3 times greater than the RMS available current? In theory, the peak available fault current can be anywhere from 1.414 x (RMS available) to 2.828 x (RMS available) in a circuit where the impedance is all reactance with no resistance. In reality all circuits include some resistance and the 2.3 multiplier has been chosen as a practical limit.

I_p VERSUS I²T

I_p has a rather limited application usefulness. Two fuses can have the same I_p but different total clearing times. See Figure 4.



The fuse that clears in time A will provide better component protection than will the fuse that clears in time B.

Fuse clearing I²t takes into account I_p and total clearing time. Fuse clearing I²t values are derived from oscillograms of fuses tested within their current-limiting range and are calculated as follows:

The “t” in the equation is the total clearing time for the fuse. To be proper, I²t should be written as (I_{RMS})²t. It is generally understood that the “I” in I²t is really I_{RMS}, and the RMS is dropped for the sake of brevity.

$$I^2t = \int_0^t I^2 dt$$

Note, from Figure 4, since clearing time “B” is approximately twice clearing time “A”, the resultant I²t for that fuse will be at least twice the I²t for the fuse with clearing time “A” and its level of protection will be correspondingly lower.

The I²t passed by a given fuse is dependent upon the characteristics of the fuse and also upon the applied voltage. The I²t passed by a given fuse will decrease as the application voltage decreases. Unless stated otherwise, published I²t values are

based on AC testing. The I²t passed by a fuse in a DC application may be higher or lower than in an AC application. The voltage, available fault current and time constant of the DC circuit are the determining factors.

Fuse I²t value can be used to determine the level of protection provided to circuit components under fault current conditions. Manufacturers of diodes, thyristors, triacs, and cable publish I²t withstand ratings for their products. The fuse chosen to protect these products should have a clearing I²t that is lower than the withstand I²t of the device being protected.

FUSE LET-THRU TABLES

APPARENT RMS SYMMETRICAL LET-THRU CURRENT

Although the current-limiting characteristics of current-limiting fuses are represented in Peak Let-Thru charts, an increasingly easy to use method of presenting this data uses Peak Let-Thru tables. The tables are based on Peak Let-Thru charts and reflect fuse tests at 15% power factor at rated voltage with prospective fault currents as high as 200,000 amperes. At each prospective fault current, let-thru data is given in two forms for an individual fuse - I_{rms} and I_p. Where I_{rms} is the “Apparent RMS Symmetrical Current” and I_p is the maximum peak instantaneous current passed by the fuse, the I_p let-thru current is 2.3 times I_{rms}. This relationship exists between peak current and RMS available current under worst-case test conditions (i.e. closing angle of 0° at 15% power factor).

Let-thru tables are easier to read than let-thru charts. Presenting let-thru data in table versus chart format reduces the possibility of misreading the information and saves time. These tables are also helpful when comparing the current-limiting capability of various fuses.

APPARENT RMS SYMMETRICAL LET-THRU CURRENT

Table 1 - Class L, A4BQ Fuses at 600 Volts AC, 15% Power Factor

Prospective Short Circuit Rms. Sym Amperes	Fuse Let-Thru Current In Kilo-Amperes																					
	By Fuse Rating In Amperes																					
	601		800		1000		1200		1600		2000		2500		3000		4000		5000		6000	
	I_{rms}	I_p	I_{rms}	I_p	I_{rms}	I_p	I_{rms}	I_p	I_{rms}	I_p	I_{rms}	I_p	I_{rms}	I_p	I_{rms}	I_p	I_{rms}	I_p	I_{rms}	I_p	I_{rms}	I_p
10,000	7.4	17	8.7	20	10	23	10	23	10	23	10	23	10	23	10	23	10	23	10	23	10	23
15,000	8.3	19	10	23	12	27	13	30	15	35	15	35	15	35	15	35	15	35	15	35	15	35
20,000	9.1	21	11	25	13	29	14	33	17	39	20	46	20	46	20	46	20	46	20	46	20	46
25,000	9.8	23	12	27	13	31	15	35	18	42	22	50	25	58	25	58	25	58	25	58	25	58
30,000	10	24	13	29	14	33	16	37	20	45	23	53	29	66	30	69	30	69	30	69	30	69
35,000	11	25	13	30	15	35	17	39	20	47	24	56	30	69	35	81	35	81	35	81	35	81
40,000	12	27	14	32	16	37	18	41	21	49	25	58	31	72	36	83	40	92	40	92	40	92
50,000	13	29	15	34	17	40	19	44	23	53	27	63	34	78	39	89	48	111	50	115	50	115
60,000	13	30	16	36	18	42	20	47	25	57	29	67	36	83	41	94	51	118	60	138	60	138
80,000	14	33	17	40	20	46	23	52	27	62	32	73	40	91	45	104	57	130	67	153	77	176
100,000	16	36	19	43	22	50	24	56	29	67	34	79	43	98	49	112	61	140	72	165	83	190
150,000	18	41	21	49	25	57	28	64	33	77	39	90	49	112	56	128	70	160	82	189	94	217
200,000	20	45	24	54	27	63	31	71	37	84	43	100	53	123	61	141	77	176	90	208	104	239

Table 2 - Class L, A4BY Fuses at 600 Volts AC, 15% Power Factor

Prospective Short Circuit Rms. Sym Amperes	Fuse Let-Thru Current In Kilo-Amperes																	
	By Fuse Rating In Amperes																	
	601		800		1000		1200		1600		2000		2500		3000		4000	
	I_{rms}	I_p	I_{rms}	I_p	I_{rms}	I_p	I_{rms}	I_p	I_{rms}	I_p	I_{rms}	I_p	I_{rms}	I_p	I_{rms}	I_p	I_{rms}	I_p
15,000	11	24	13	29	15	35	15	35	15	35	15	35	15	35	15	35	15	35
20,000	12	26	14	32	16	37	19	43	20	46	20	46	20	46	20	46	20	46
25,000	13	29	15	34	18	40	20	46	24	55	25	58	25	58	25	58	25	58
30,000	13	30	16	36	19	43	21	49	25	58	29	67	30	69	30	69	30	69
35,000	14	32	17	38	20	45	23	52	27	61	30	70	33	76	35	81	35	81
40,000	15	34	17	40	21	47	24	54	28	64	32	73	35	79	37	86	40	92
50,000	16	36	19	43	22	51	25	58	30	68	34	78	37	86	41	95	50	115
60,000	17	38	20	45	24	54	27	62	31	72	37	84	40	91	44	100	53	121
80,000	18	42	22	50	26	59	29	67	35	80	40	92	44	100	48	110	58	133
100,000	20	45	24	54	28	64	32	73	38	87	43	99	47	108	52	119	62	143
150,000	23	52	27	62	32	73	37	84	43	99	49	113	54	123	59	137	73	167
200,000	25	56	29	67	35	80	40	91	48	110	54	123	59	136	65	150	79	181

Table 3 - Class L, A4BT Fuses at 600 Volts AC, 15% Power Factor

Prospective Short Circuit Rms. Sym Amperes	Fuse Let-Thru Current In Kilo-Amperes									
	By Fuse Rating In Amperes									
	800		1000		1200		1600		2000	
	I_{rms}	I_p	I_{rms}	I_p	I_{rms}	I_p	I_{rms}	I_p	I_{rms}	I_p
15,000	14	33	15	35	15	35	15	35	15	35
20,000	16	36	18	41	20	46	20	46	20	46
25,000	17	39	19	45	22	50	25	58	25	58
30,000	18	41	21	48	23	54	28	63	30	69
35,000	19	43	22	50	25	56	29	67	34	79
40,000	20	45	23	52	26	59	30	70	35	81
50,000	21	49	25	56	28	63	33	75	38	87
60,000	23	52	26	60	29	67	35	80	40	93
80,000	25	57	29	66	32	74	38	88	44	102
100,000	27	62	31	71	35	80	41	95	48	110
150,000	31	70	35	81	40	92	47	109	55	126
200,000	34	78	39	89	44	101	52	120	60	139

APPARENT RMS SYMMETRICAL LET-THRU CURRENT

Table 4 - Class RK1, A6K Fuses at 600 Volts AC, 15% Power Factor

Prospective Short Circuit Rms. Sym Amperes	Fuse Let-Thru Current In Kilo-Amperes											
	By Fuse Rating In Amperes											
	30		60		100		200		400		600	
	rms	p	rms	p	rms	p	rms	p	rms	p	rms	p
5,000	.63	1.4	1.4	3.2	2.0	4.6	3.2	7.4	4.6	11	5.0	11.5
10,000	.80	1.8	1.7	3.9	2.6	6.0	4.0	9.2	5.8	13	7.5	17
15,000	.91	2.1	2.0	4.6	2.9	6.7	4.6	11	6.7	15	8.6	20
20,000	1.0	2.3	2.2	5.1	3.2	7.4	5.0	12	7.4	17	9.5	22
25,000	1.1	2.5	2.4	5.5	3.5	8.1	5.4	12	7.9	18	10	23
30,000	1.2	2.6	2.5	5.8	3.7	8.5	5.8	13	8.4	19	11	25
35,000	1.2	2.8	2.6	6.0	3.9	9.0	6.1	14	8.9	20	11	26
40,000	1.3	2.9	2.8	6.4	4.1	9.4	6.3	14	9.3	21	12	27
50,000	1.4	3.1	3.0	6.9	4.4	10	6.8	16	10	23	13	30
60,000	1.4	3.3	3.2	7.4	4.7	11	7.3	17	11	24	14	32
80,000	1.6	3.7	3.5	8.1	5.1	12	8.0	18	12	27	15	35
100,000	1.7	3.9	3.7	8.5	5.5	13	8.6	20	13	29	16	37
150,000	2.0	4.5	4.4	9.9	6.3	14	9.9	23	14	33	19	43
200,000	2.2	4.9	4.7	11	7.0	16	11	25	16	37	20	47

Table 5 - Class RK1, A6D Fuses at 600 Volts AC, 15% Power Factor

Prospective Short Circuit Rms. Sym Amperes	Fuse Let-Thru Current In Kilo-Amperes											
	By Fuse Rating In Amperes											
	30		60		100		200		400		600	
	rms	p	rms	p	rms	p	rms	p	rms	p	rms	p
5,000	.80	1.8	1.5	3.5	2.0	4.6	3.5	8.0	5.0	12	-	-
10,000	1.0	2.3	1.9	4.4	2.5	5.8	4.4	10.1	7.1	16.4	10	23
15,000	1.2	2.7	2.2	4.9	2.9	6.6	5.0	11.6	8.2	18.8	12	27
20,000	1.3	2.9	2.4	5.4	3.1	7.1	5.5	12	9.0	20.7	13	29
25,000	1.4	3.2	2.6	5.9	3.4	7.8	6.0	13.8	9.7	22.3	14	32
30,000	1.5	3.4	2.7	6.2	3.6	8.3	6.3	14.6	10.3	23.6	15	33
35,000	1.5	3.5	2.9	6.6	3.8	8.7	6.7	15.4	10.8	24.9	15	35
40,000	1.6	3.7	3.0	6.9	4.0	9.1	7.0	16.5	11.3	26	16	37
50,000	1.7	4.0	3.2	7.4	4.3	9.8	7.5	16.5	12.2	28	17	40
60,000	1.8	4.2	3.4	7.8	4.5	11	8.0	17	13	30	18	42
80,000	2.0	4.7	3.8	8.6	5.0	12	8.8	20.3	13	33	20	46
100,000	2.2	5.0	4.1	9.3	5.4	12	9.5	20	14	35	22	50
150,000	2.5	5.8	4.6	11	6.1	14	10.9	25	16	40	25	57
200,000	2.8	6.3	5.1	12	6.8	16	11	25	19	45	27	63

Table 6 - Class J, A4J Fuses at 600 Volts AC, 15% Power Factor

Prospective Short Circuit Rms. Sym Amperes	Fuse Let-Thru Current In Kilo-Amperes											
	By Fuse Rating In Amperes											
	30		60		100		200		400		600	
	rms	p	rms	p	rms	p	rms	p	rms	p	rms	p
5,000	.85	2.0	1.4	3.2	2.0	4.6	3.1	7.2	4.5	10	5.0	12
10,000	1.1	2.5	1.8	4.4	2.8	6.4	3.6	8.2	5.7	13	8.7	20
15,000	1.2	2.8	2.0	4.6	2.9	6.6	4.1	9.4	6.5	15	9.9	23
20,000	1.4	3.1	2.4	5.1	3.2	7.3	4.5	10	7.1	16	11	25
25,000	1.5	3.4	2.4	5.5	3.8	8.7	5.3	12	7.7	18	12	27
30,000	1.6	3.6	2.5	5.8	4.0	9.2	5.5	13	8.2	19	13	29
35,000	1.6	3.7	2.7	6.2	4.2	9.7	5.9	14	8.6	20	13	30
40,000	1.7	3.9	2.8	6.4	4.5	10	6.0	14	9.0	21	14	32
50,000	1.8	4.2	3.0	6.9	4.7	11	6.1	14	9.7	22	15	34
60,000	2.0	4.5	3.2	7.4	5.0	11	6.5	15	10	23	16	36
80,000	2.2	4.9	3.5	8.1	5.5	12	7.1	16	11	25	17	40
100,000	2.3	5.3	3.8	9.5	6.0	14	7.7	18	12	28	19	43
150,000	2.7	6.1	4.7	10.9	6.8	16	8.8	20	14	32	21	49
200,000	2.9	6.7	4.8	11	7.5	17	9.7	22	15	35	24	54

APPARENT RMS SYMMETRICAL LET-THRU CURRENT

Table 7 - Class J, AJT Fuses at 600 Volts AC, 15% Power Factor

Prospective Short Circuit Rms. Sym Amperes	Fuse Let-Thru Current In Kilo-Amperes											
	By Fuse Rating In Amperes											
	30		60		100		200		400		600	
	I_{rms}	I_p	I_{rms}	I_p	I_{rms}	I_p	I_{rms}	I_p	I_{rms}	I_p	I_{rms}	I_p
5,000	.79	1.8	1.2	2.8	1.8	4.0	3.1	7.0	4.8	11	5.0	12
10,000	1.0	2.3	1.6	3.6	2.2	5.1	3.8	8.8	6.0	14	8.3	19
15,000	1.2	2.6	1.8	4.1	2.5	5.8	4.4	10	6.9	16	9.5	22
20,000	1.3	2.9	2.0	4.5	2.8	6.4	4.8	11	7.6	18	11	24
25,000	1.4	3.1	2.1	4.8	3.0	6.9	5.2	12	8.2	19	11	26
30,000	1.4	3.3	2.2	5.1	3.2	7.4	5.5	13	8.7	20	12	28
35,000	1.5	3.5	2.4	5.4	3.4	7.7	5.8	13	9.1	21	13	29
40,000	1.6	3.7	2.5	5.6	3.5	8.1	6.1	14	9.6	22	13	30
50,000	1.7	3.9	2.7	6.1	3.8	8.7	6.6	15	10.3	24	14	33
60,000	1.8	4.2	2.8	6.4	4.0	9.2	7.0	16	11	25	15	35
80,000	2.0	4.6	3.1	7.1	4.4	10	7.7	18	12	28	17	38
100,000	2.2	4.9	3.3	7.6	4.8	11	8.3	19	13	30	18	41
150,000	2.5	5.7	3.8	8.7	5.4	12	9.5	22	15	34	21	47
200,000	2.7	6.2	4.2	9.7	6.0	14	10.4	24	16	37	23	59

Table 8 - Class T, A6T Fuses at 600 Volts AC, 15% Power Factor

Prospective Short Circuit Rms. Sym Amperes	Fuse Let-Thru Current In Kilo-Amperes													
	By Fuse Rating In Amperes													
	30		60		100		200		400		600		800	
	I_{rms}	I_p	I_{rms}	I_p	I_{rms}	I_p	I_{rms}	I_p	I_{rms}	I_p	I_{rms}	I_p	I_{rms}	I_p
5,000	.62	1.4	1.2	2.8	1.6	3.8	2.6	6.0	4.2	9.7	5.0	12	5.0	12
10,000	.78	1.8	1.5	3.5	2.1	4.8	3.3	7.5	5.3	12	8.2	19	10	22
15,000	.89	2.1	1.7	4.0	2.4	5.4	3.7	8.6	6.1	14	9.4	22	11	26
20,000	.98	2.3	1.9	4.4	2.6	6.0	4.1	9.5	6.7	15	10	24	12	28
25,000	1.1	2.4	2.0	4.8	2.8	6.5	4.4	10	7.2	17	11	26	13	31
30,000	1.1	2.6	2.2	5.0	3.0	6.9	4.7	11	7.7	18	12	27	14	32
35,000	1.2	2.7	2.3	5.3	3.1	7.2	5.0	11	8.1	19	12	29	15	34
40,000	1.2	2.9	2.4	5.6	3.3	7.5	5.2	12	8.5	19	13	30	16	36
50,000	1.3	3.1	2.6	6.0	3.5	8.1	5.6	13	9.1	21	14	32	17	38
60,000	1.4	3.3	2.8	6.4	3.8	8.6	5.9	14	9.7	22	15	34	18	41
80,000	1.6	3.6	3.0	7.0	4.1	9.5	6.5	15	11	25	16	38	20	45
100,000	1.7	3.9	3.2	7.5	4.5	10	7.0	16	11	26	18	40	21	48
150,000	1.9	4.4	3.8	8.6	5.1	12	8.1	19	13	30	20	46	24	55
200,000	2.1	4.9	4.1	9.5	5.6	13	8.9	20	14	33	22	51	27	61

Table 9 - Class T, A3T Fuses at 300 Volts AC, 15% Power Factor

Prospective Short Circuit Rms. Sym Amperes	Fuse Let-Thru Current In Kilo-Amperes															
	By Fuse Rating In Amperes															
	30		60		100		200		400		600		800		1200	
	I_{rms}	I_p	I_{rms}	I_p	I_{rms}	I_p	I_{rms}	I_p	I_{rms}	I_p	I_{rms}	I_p	I_{rms}	I_p	I_{rms}	I_p
5,000	.53	1.2	.95	2.2	1.4	3.1	2.0	4.6	3.0	6.9	4.5	10	5.0	12	5.0	12
10,000	.66	1.5	1.2	2.8	1.7	3.9	2.5	5.8	3.8	8.7	5.6	13	7.2	16	9.3	21
15,000	.76	1.7	1.4	3.2	2.0	4.5	2.9	6.6	4.4	10	6.4	15	8.2	19	11	24
20,000	.83	1.9	1.5	3.5	2.1	4.8	3.1	7.1	4.8	11	7.0	16	9.0	21	12	27
25,000	.90	2.1	1.6	3.7	2.3	5.3	3.4	7.8	5.2	12	7.6	17	9.7	22	13	29
30,000	.96	2.2	1.7	3.9	2.5	5.6	3.6	8.3	5.5	13	8.1	19	10	24	13	31
35,000	1.0	2.3	1.8	4.1	2.6	6.0	3.8	8.7	5.8	13	8.5	20	11	25	14	32
40,000	1.1	2.4	1.9	4.4	2.7	6.2	4.0	9.2	6.0	14	8.9	20	11	26	15	34
50,000	1.1	2.6	2.1	4.7	2.9	6.7	4.3	9.9	6.5	15	9.6	22	12	28	16	37
60,000	1.2	2.8	2.2	5.1	3.1	7.1	4.5	10	6.9	16	10	23	13	30	17	39
80,000	1.3	3.1	2.4	5.5	3.4	7.8	5.0	12	7.6	17	11	26	14	33	19	43
100,000	1.4	3.3	2.6	6.0	3.7	8.4	5.4	12	8.2	19	12	28	15	35	20	46
150,000	1.6	3.7	3.0	6.8	4.2	9.7	6.1	14	9.4	22	14	32	18	41	23	53
200,000	1.8	4.1	3.3	7.5	4.6	11	6.8	16	10	24	15	35	19	45	25	58

APPARENT RMS SYMMETRICAL LET-THRU CURRENT

Table 10 - Class RK1, A2K Fuses at 250 Volts AC, 15% Power Factor

Prospective Short Circuit Rms. Sym Amperes	Fuse Let-Thru Current In Kilo-Amperes											
	By Fuse Rating In Amperes											
	30		60		100		200		400		600	
	I _{rms}	I _p	I _{rms}	I _p	I _{rms}	I _p	I _{rms}	I _p	I _{rms}	I _p	I _{rms}	I _p
5,000	.61	1.4	1.4	3.2	1.7	4.0	2.9	6.7	4.4	10	5.0	12
10,000	.77	1.8	1.7	4.0	2.2	5.0	3.7	8.5	5.5	13	7.4	17
15,000	.88	2.0	2.0	4.6	2.5	5.8	4.2	9.7	6.3	14	8.5	19
20,000	.97	2.2	2.2	5.0	2.8	6.3	4.6	11	6.9	16	9.3	21
25,000	1.1	2.4	2.4	5.4	3.0	6.8	5.0	12	7.4	17	10	23
30,000	1.1	2.6	2.5	5.8	3.2	7.3	5.3	12	7.9	18	11	25
35,000	1.2	2.7	2.6	6.0	3.3	7.7	5.6	13	8.3	19	11	26
40,000	1.2	2.8	2.8	6.3	3.5	8.0	5.9	13	8.7	20	12	27
50,000	1.3	3.0	3.0	6.8	3.8	8.6	6.3	14	9.4	22	13	29
60,000	1.4	3.2	3.2	7.2	4.0	9.2	6.7	15	10	23	13	31
80,000	1.5	3.5	3.5	8.0	4.4	10	7.4	17	11	25	15	34
100,000	1.7	3.8	3.7	8.6	4.7	11	7.9	18	12	27	16	37
150,000	1.9	4.4	4.3	9.8	5.4	12	9.1	21	14	31	18	42
200,000	2.1	4.8	4.7	11	6.0	14	10	23	15	34	20	46

Table 11 - Class RK1, A2D Fuses at 250 Volts AC, 15% Power Factor

Prospective Short Circuit Rms. Sym Amperes	Fuse Let-Thru Current In Kilo-Amperes											
	By Fuse Rating In Amperes											
	30		60		100		200		400		600	
	I _{rms}	I _p	I _{rms}	I _p	I _{rms}	I _p	I _{rms}	I _p	I _{rms}	I _p	I _{rms}	I _p
5,000	.77	1.8	1.4	3.2	2.0	4.6	3.2	7.3	5.0	12	5.0	12
10,000	.97	2.2	1.8	4.0	2.5	5.8	4.0	9.2	6.4	15	8.0	18
15,000	1.1	2.6	2.0	4.6	2.9	6.6	4.6	11	7.3	17	9.2	21
20,000	1.2	2.8	2.2	5.1	3.2	7.3	5.0	12	8.1	19	10	23
25,000	1.3	3.0	2.4	5.5	3.4	7.9	5.4	12	8.7	20	11	25
30,000	1.4	3.2	2.5	5.8	3.6	8.3	5.8	13	9.2	21	12	27
35,000	1.5	3.4	2.7	6.1	3.8	8.8	6.1	14	9.7	22	12	28
40,000	1.5	3.5	2.8	5.7	4.0	9.2	6.4	15	10	23	13	29
50,000	1.7	3.8	3.0	6.9	4.3	9.9	6.8	16	11	25	14	32
60,000	1.8	4.0	3.2	7.3	4.6	11	7.3	17	12	27	15	34
80,000	1.9	4.5	3.5	8.1	5.0	12	8.0	18	13	29	16	37
100,000	2.1	4.8	3.8	8.7	5.4	12	8.6	20	14	32	17	40
150,000	2.4	5.5	4.3	9.9	6.2	14	9.9	23	16	36	20	46
200,000	2.6	6.0	4.8	11	6.8	16	11	25	17	40	22	50

Table 12 - Class RK5, TRS Fuses at 600 Volts AC, 15% Power Factor

Prospective Short Circuit Rms. Sym Amperes	Fuse Let-Thru Current In Kilo-Amperes											
	By Fuse Rating In Amperes											
	30		60		100		200		400		600	
	I _{rms}	I _p	I _{rms}	I _p	I _{rms}	I _p	I _{rms}	I _p	I _{rms}	I _p	I _{rms}	I _p
5,000	1.7	3.9	3.2	7.4	3.4	7.8	5.0	12	-	-	-	-
10,000	2.1	4.8	4.0	9.2	4.2	9.7	6.2	14	10	23	10	23
15,000	2.4	5.5	4.6	11	4.8	11	7.1	16	12	27	15	35
20,000	2.7	6.2	5.1	12	5.3	12	7.8	18	13	30	18	42
25,000	2.9	6.7	5.5	13	5.7	13	8.4	19	14	32	20	45
30,000	3.1	7.1	5.8	13	6.1	14	8.9	20	15	35	21	48
35,000	3.3	7.6	6.1	14	6.4	15	9.4	22	16	36	22	50
40,000	3.4	7.8	6.4	15	6.7	15	9.8	23	17	38	23	53
50,000	3.7	8.5	6.9	16	7.2	17	11	24	18	41	25	57
60,000	3.9	9.0	7.3	17	7.7	18	11	26	19	43	26	60
80,000	4.3	9.9	8.1	19	8.5	20	12	29	21	48	29	66
100,000	4.6	11	8.7	20	9.1	21	13	31	22	52	31	72
150,000	5.3	12	9.9	23	10	24	15	35	26	59	36	82
200,000	5.8	13	11	25	12	26	17	39	28	65	39	90

APPARENT RMS SYMMETRICAL LET-THRU CURRENT

Table 13 - Class RK5, TR Fuses at 250 Volts AC, 15% Power Factor

Prospective Short Circuit Rms. Sym Amperes	Fuse Let-Thru Current In Kilo-Amperes											
	By Fuse Rating In Amperes											
	30		60		100		200		400		600	
	rms	p	rms	p	rms	p	rms	p	rms	p	rms	p
5,000	1.4	3.2	3.0	6.9	3.2	7.4	5.0	12	-	-	-	-
10,000	1.8	4.1	3.8	8.7	4.1	9.4	6.6	15	10	23	10	23
15,000	2.1	4.8	4.4	10	4.7	11	7.6	17	13	29	15	35
20,000	2.3	5.3	4.8	11	5.1	12	8.4	19	14	32	19	44
25,000	2.5	5.6	5.2	12	5.5	13	9.0	21	15	34	21	48
30,000	2.6	6.0	5.5	13	5.9	14	9.6	22	16	37	22	50
35,000	2.7	6.2	5.8	13	6.2	14	10	23	17	38	23	53
40,000	2.9	6.7	6.1	14	6.5	15	11	24	18	40	24	56
50,000	3.1	7.1	6.5	15	7.0	16	11	26	19	43	26	60
60,000	3.3	7.6	7.0	16	7.4	17	12	27	20	46	28	63
80,000	3.6	8.3	7.7	18	8.1	19	13	31	22	51	30	70
100,000	3.9	9.0	8.3	19	8.8	20	14	33	24	55	33	75
150,000	4.4	10	9.4	22	10	23	16	38	27	62	38	86
200,000	4.9	11	11	24	11	26	18	41	30	69	41	95

The primary responsibility of a capacitor fuse is to isolate a shorted capacitor before the capacitor can damage surrounding equipment or personnel. Typical capacitor failure occurs when the dielectric in the capacitor is no longer able to withstand the applied voltage. A low impedance current path results. The excessive heat generated builds pressure and can cause violent case rupture. A fuse will isolate the shorted capacitor before case rupture occurs.

FUSE PLACEMENT

The Code requires that an overcurrent device be placed in each ungrounded conductor of each capacitor bank (see Figure 1). The Code further requires that the rating or setting of the overcurrent device be as low as practicable. A separate overcurrent device is not required if the capacitor is connected on the load side of a motor-running overcurrent device.

Fusing per the Code provides reasonable protection if the capacitors are the metallized film self-healing type. If not, each capacitor should be individually fused as shown in Figure 2.

Fusing each individual capacitor is especially important in large banks of parallel capacitors. Should one capacitor fail, the parallel capacitors will discharge into the faulted capacitor and violent case rupture of the faulted capacitor can result. Individual capacitor fusing eliminates this problem.

If the capacitors are to be placed in banks comprised of both series and parallel combinations, the capacitor manufacturer must be consulted for fuse placement recommendations. The opening of improperly placed fuses can cause overvoltage and result in damage to other capacitors in the network.

AMPERE RATING

How much overcurrent can a capacitor withstand? What effects do neighboring capacitors have on the inrush of a given capacitor? These and other questions influence fuse selection. Circuit analysis can be very complex. It is best to consult the capacitor manufacturer for specific recommendations.

For applications 600V or less in lieu of specific fusing recommendations from the capacitor manufacturer, we suggest a Mersen A60C Type 121 or an A6Y Type 2SG fuse sized at 165% to 200% of the capacitor's current rating (contact factory for technical data). If these fuses are not dimensionally acceptable, then a non-time delay Class J or Class RK1 fuse could be used and sized at 185% to 220% of the capacitor's current rating.

For applications over 600V to 5.5kV, we suggest Amp-Trap A100C to A550C capacitor fuses. These medium voltage fuses are available in a variety of voltage ratings and mounting configurations. Refer to Section MV for specific data. Medium voltage capacitor fuses are sized at 165% to 200% of the capacitor current rating.

Capacitor fuses are selected for their ability to provide short circuit protection and to ride through capacitor inrush current. Inrush current is affected by the closing angle, capacitance, resistance and inductance of the circuit, and varies from one application to another. Inrush lasts for less than 1/4 cycle and is typically less than 25 times the capacitor's current rating.

Steady state capacitor current is proportional to the applied voltage and frequency. Since voltage and frequency are fixed in power factor correction applications, the capacitor is not expected to be subjected to an overload. Therefore, capacitor fuses are not selected to provide overload protectors for the capacitor.

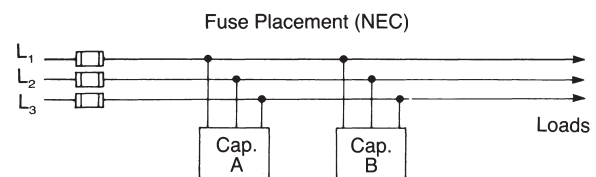

Figure 1

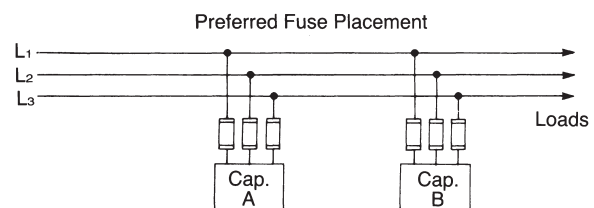

Figure 2

kVAR VS. AMPS

The capacitor's current rating can be derived from its kVAR rating by using the following formula:

$$\frac{\text{kVAR} \times 1000}{\text{volts}} = \text{amps}$$

1 kVAR = 1000VA (Reactive)

Example#1: What fuse would you recommend for a three phase capacitor rated 100kVAR at 480 volts?

$$\frac{100,000 \text{ volt-amps}}{480 \text{ volts}} = 208 \text{ amps}$$

To determine line current, we must divide the 208 amps, which is the three phase current by $\sqrt{3}$:

$$\frac{208}{\sqrt{3}} = 120 \text{ amps}$$

If an A6OC Type 121 fuse is to be used, size the fuse at 165% to 200% of line current.

$$120 \text{ amps} \times 1.65 = 198 \text{ amps}$$

$$120 \text{ amps} \times 2.00 = 240 \text{ amps}$$

Suggestions: A60C200-121 or A60C200-121TI

If a Class J or a Class RK1 is to be used, size the fuse at 185% to 220% of line current.

$$120 \text{ amps} \times 1.85 = 222 \text{ amps}$$

$$120 \text{ amps} \times 2.20 = 264 \text{ amps}$$

Suggestions: A4J225 or A6K225R

Example#2: What fuse would you recommend for a three phase capacitor rated 2.4kV, 100kVAR?

Calculate Capacitor Current =

$$\frac{100,000 \text{ volt-amps}}{\sqrt{3} \times 2400\text{V}} = 24\text{A}$$

$$\text{fuse size } 24 \times 1.65 = 39\text{A}$$

$$24 \times 2.00 = 48\text{A}$$

We suggest a 40 or 50 amp fuse rated at least 2400V A250C50-XX, where XX is the type of mounting needed.

USING CABLE PROTECTORS

Cable Protectors are special purpose limiters which are used to protect service entrance and distribution cable runs. The National Electrical Code (NEC) does not require using cable protectors.





When unprotected cables are paralleled, a single conductor faulting to ground can result in damage to and eventual loss of all parallel conductors. The resultant cost of cable replacement, loss of service, and down time can be significant. This cost can be minimized by the use of Cable Protectors.

When each phase consists of three or more parallel conductors, Cable Protectors are installed at each end of each conductor. Should one cable fault, the Cable Protectors at each end of the faulted cable will open and isolate the faulted cable. The unfaulted cables will maintain service.

TERMINATIONS

In addition to improving system reliability, Cable Protectors provide a means of terminating cable, thus eliminating the need for cable lugs. Cable Protectors are available with the following configurations:

Aluminum and copper cable require different terminations. Cable Protectors intended for copper cable must not be used with aluminum cable. Cable Protectors intended for aluminum cable include an oxide inhibitor.

Cable to cable		Type 1
Cable to offset bus		Type 3
Bus to offset bus		Type 5
Mole to cable		Type 6
Mole to offset bus		Type 8

PLACEMENT OF CABLE PROTECTORS

In single phase applications where a single transformer supplies the service and there are only one or two conductors per phase, a single Cable Protector per cable may be used. The Cable Protector should be located at the supply end of the cable. In all other applications, Cable Protectors

should be placed at both ends of each cable. This allows a faulted cable to be isolated from the source end and from a back feed at its load end. Isolation of a faulted cable is only possible if there are 3 or more parallel cables per phase.

CABLE PROTECTOR AMPACITY

Cable Protectors are not ampere rated. They are not intended to provide overload protection for the cable. Cable Protectors are designed to open in case of a short circuit or after a cable has faulted. Thus total system reliability is maximized. For these reasons Cable Protectors are rated in terms of the cable material (aluminum or copper) and the cable size (250kcmil, 500kcmil, etc.)

SELECTING A CABLE PROTECTOR

The following questions must be answered to choose the correct Cable Protector:

- Is the cable copper or aluminum?
- What is the cable size?
- What termination type is desired?
- Is the Cable Protector to be insulated or protected with a heat-shrink sleeve or a rubber boot?

Once these questions have been answered, the Cable Protector catalog number can be chosen from the listings.

SMALL CABLE SIZES

Class J fuses may be used for cable sizes smaller than 4/0. Since Class J blades are drilled for bolting, they may be attached directly to bus. Cables must be prepared by installing lugs before bolting to the fuse. Cable-to-bus or cable-to-cable terminations are possible. The following ampere ratings are recommended, or each cable size.

Cable - Size Awg CU or AL	Class J Fuse Catalog No.
#4	A4J125
#3	A4J150
#2	A4J175
#1	A4J200
1/0	A4J250
2/0	A4J300
3/0	A4J400

TYPICAL CONSTRUCTION OF A MOTOR STARTER

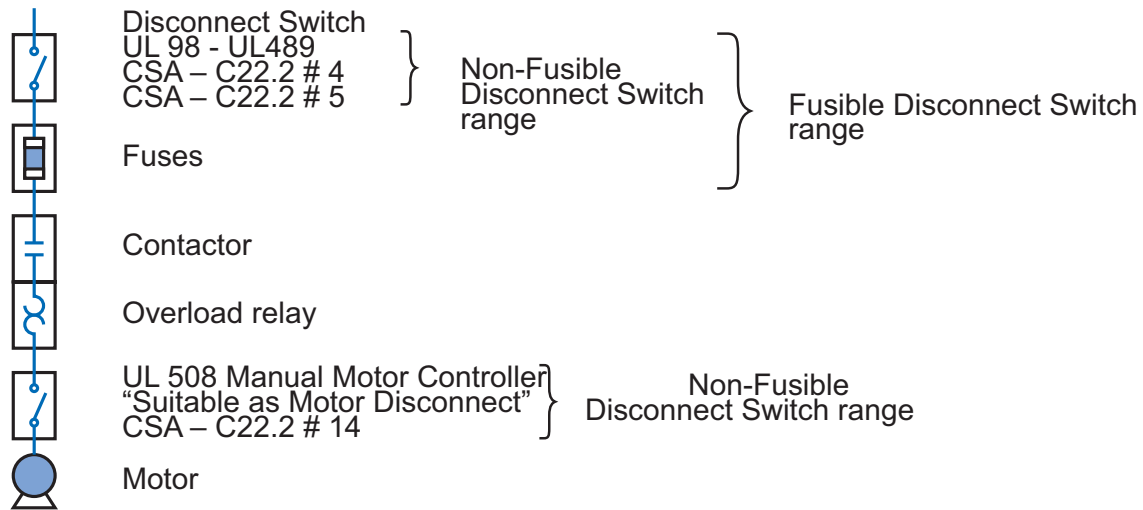

ESSENTIAL PARTS OF A MOTOR BRANCH CIRCUIT REQUIRED BY THE NATIONAL ELECTRICAL CODE:

- Disconnect means
- Branch-circuit short-circuit protective device
- Motor-controller
- Motor overload protective devices

DISCONNECT MEANS

The Disconnect means can be a Manual Disconnect Switch according to UL 98.

A manual Motor Controller (according to UL 508) additionally marked "Suitable as Motor Disconnect" is only permitted as a disconnecting means where installed between the final branch-circuit short-circuit and ground-fault protective device and the motor (NEC 2008 Article 430.109).

BRANCH-CIRCUIT SHORT-CIRCUIT PROTECTIVE DEVICE

The short-circuit protective device can be either a Fuse or an Inverse-time Circuit-breaker.

MOTOR-CONTROLLER

Any switch or device that is normally used to start and stop a motor according to the National Electrical Code article 430.82.

MOTOR OVERLOAD PROTECTIVE DEVICES

The National Electrical Code permits fuses to be used as the sole means of overload protection for motor branch circuits. This approach is often practical only with small single phase motors. Most integral horsepower 3 phase motors are controlled by a motor starter which includes an overload relay. Since the overload relay provides overload protection for the motor branch circuit, the fuses may be sized for short-circuit protection.

AUXILIARY CONTACT WIRING DIAGRAMS

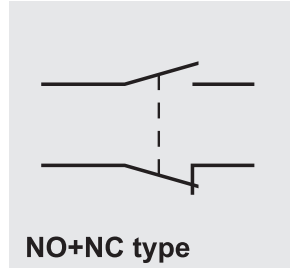
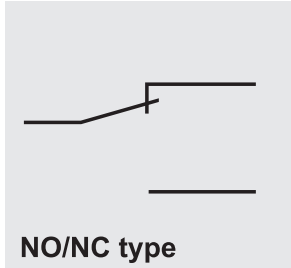

AUXILIARY CONTACT RATING CODES (ACCORDING TO UL508 STANDARD ITEM 139)

Designation

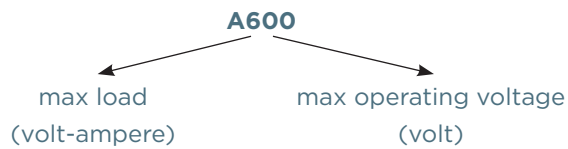

These codes concern the auxiliary contacts and give the maximum load they can make or break. The numerical suffix designates the maximum voltage design values, which are to be 600, 300, and 150 volts for suffixes 600, 300, and 150 respectively. The table below gives some typical rating codes:

Example

A contactor used at 600VAC - 60 Hz has the following specifications:

Average consumption: - inrush 60 Hz: 1200VA
- sealed 60 Hz: 120VA

Thus a C600 rated auxiliary device is the minimum rating required.

Contact Rating Code Designation	Max Operating Voltage [V]	Network Type	Making Max Load [VA]	Breaking Max Load [VA]
A600	600	AC	7200	720
B600	600	AC	3600	360
C600	600	AC	1800	180
D300	300	AC	432	72
E150	150	AC	216	36
N600	600	DC	275	275
P600	600	DC	138	138
Q600	600	DC	69	69
R300	300	DC	28	28

Note: A600 and N600 are the highest categories and may be used to cover all cases.

DEFINITION

Coordination is defined as properly localizing a fault condition to restrict outages to the equipment affected, accomplished by choice of selective fault protective devices.

Coordination (selectivity, discrimination) is desirable and often times mandatory. A lack of coordination can represent a hazard to people and equipment. When designing for coordination, fuses provide distinct advantages over other types of overcurrent protective devices.

To coordinate a circuit breaker protected system, it is generally necessary to intentionally delay the short circuit response of upstream breakers. Though coordination may be achieved, short circuit protection is compromised. The speed and consistency of response of fuses allows coordination without compromising component protection.

The terms coordination and selectivity are often used interchangeably. The term coordination should be used to describe a system as defined above, while

two fuses are said to be selective if the downstream fuse opens while the upstream fuse remains operable under ALL conditions of overcurrent. The term “discrimination” is synonymous with selectivity and is the preferred international term for this definition.

The word ALL is key. Fuse selectivity cannot be assured by comparing fuse time current curves alone. These curves stop at .01 second. Fuse performance under high fault conditions must also be evaluated. Fuse I²t is the best tool for assuring coordination under high fault current conditions. If the total clearing I²t of the downstream fuse is less than the melting I²t of the main upstream fuse, the fuses will be selective under high fault conditions.

To simplify presenting weighty I²t data, selectivity information can simply be found in selectivity ratio tables.

The ratios found in the following tables are conservative and are appropriate for all overcurrents up to 200,000 amperes RMS. In some cases smaller ratios than shown may be used. Consult your Mersen representative for specific recommendations.

FUSE SELECTIVITY RATIOS - 600 AND 480 VOLT APPLICATIONS UP TO 200,000 RMS SYMMETRICAL AMPERES

Branch Fuse	Ratio (For Fuses Rated 61 – 6000A) Main Fuse								
	A4BQ	A4BY	A4BT	TRS	A6K	A6D	A4J	AJT	A6T
A4BQ	2:1	2:1	2:1	-	-	-	-	-	-
A4BY	-	2.5:1	2:1	-	-	-	-	-	-
A4BT	2.5:1	2.5:1	2:1	-	-	-	-	-	-
TRS	4:1	4:1	3:1	2:1	4:1	4:1	4:1	3:1	4.5:1
A6K	2:1	2:1	1.5:1	1.5:1	2:1	2:1	3:1	2:1	3.5:1
A6D	2:1	2:1	1.5:1	1.5:1	2:1	2:1	3:1	2:1	3.5:1
A4J	2:1	2:1	1.5:1	1.5:1	2:1	2:1	2:1	2:1	3:1
AJT	2:1**	2:1**	2:1	1.5:1	2:1	2:1	2.5:1	2:1	3.5:1
A6T	3:1	2.5:1	2:1	1.5:1	2:1	2:1	2:1	2:1	2.5:1

FUSE SELECTIVITY RATIOS - 240 VOLT APPLICATIONS UP TO 200,000 RMS SYMMETRICAL AMPERES

Branch Fuse	Ratio (For Fuses Rated 61 – 6000A) Main Fuse								
	A4BQ	A4BY	A4BT	TR	A2K	A2D	A4J	AJT	A3T
A4BQ	2:1	2:1	2:1	-	-	-	-	-	-
A4BY	-	2.5:1	2:1	-	-	-	-	-	-
A4BT	2.5:1	2.5:1	2:1	-	-	-	-	-	-
TR	4:1	4:1	4:1	1.5:1	4:1	3:1	4:1	3:1	5:1
A2K	2:1	2:1	1.5:1	1.5:1	2:1	1.5:1	2:1	1.5:1	3:1
A2D	2.5:1	2.5:1	2:1	1.5:1	2:1	1.5:1	2:1	2:1	3:1
A4J	2:1	2:1	1.5:1	1.5:1	2:1	1.5:1	2:1	2:1	3:1
AJT	2:1	2:1	2:1	1.5:1	2.5:1	2:1	2.5:1	2:1	3:1
A3T	1.5:1	1.5:1	1.5:1	1.5:1	1.5:1	1.5:1	1.5:1	1.5:1	2:1

**Exception: For AJT450-600 use 2:1 on 480V only, 2.25:1 on 600V.

HOW MANY FUSES WILL OPEN ON A SHORT CIRCUIT?

In a three phase system typically only two fuses will open on a line-to-line short circuit. Since all three line currents are offset from each other (see chart to the right), each fuse will see the full fault at different times. Therefore the fuses will open at different times, once the first two fuses open, the circuit is disconnected and the third one typically never sees the full fault current. The third line can only conduct current directly to ground.

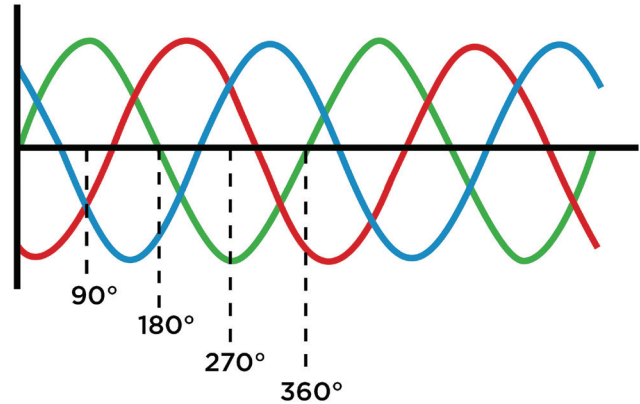

How many fuses will open on an overload?

Similar to a short circuit typically two fuses will open on an overload. Typically, one fuse opening will not be adequate to disconnect all three phases so the two remaining phases will conduct the overcurrent until one of them opens. At this point, the last fuse will only be able to conduct current directly to ground so it most likely will not open.

Is it ok to replace only the open fuses?

It is always recommended to replace all three fuses. In both short circuit and overload conditions the third fuse might not open but there is no way to tell how much of the element may have melted due to the overcurrent. Not replacing the third fuse can lead to issues in the future such as nuisance openings which can result in costly downtime.

Is there a life expectancy on my fuse?

A fuse does not have a “mean time between failures” because theoretically a fuse only needs to be replaced once it opens on an overcurrent. Fuses are 100% tested before leaving the factory to ensure that they will perform as intended. In the real world, factors such as temperature and humidity can cause a fuse to need replacement. Mersen suggests using ten years as a guideline for replacing both fuses installed and in inventory.



Fuses are 100% tested before leaving the factory to ensure they will perform as intended.

SHORT CIRCUIT RATING (SCCR)

The National Electric Code (2017) defines Short-Circuit Current Rating (article 100) as “the prospective symmetrical fault current at a normal voltage to which an apparatus or system is able to be connected without sustaining damage exceeding defined acceptance criteria.” SCCR is important to provide for safety of people and equipment during short-circuit conditions.

Article 409.110 (3) states that industrial control panels shall be marked with “short-circuit current rating of the industrial control panel based on one of the following: (a) short-circuit current rating of a listed and labeled assembly (b) short-circuit current rating established utilizing an approved method.” The fine print note refers to UL 508A, supplement SB as an example of an approved method. 430.8 require motor controllers to be marked with an SCCR.

Supplement SB in UL 508A uses a four step process to determine what a short circuit current rating for a panel should be. This process identifies the components with the lowest individual SCCR in the circuit. If there is no feeder over-current protective device (OCPD) this component is the weakest link and would determine the overall SCCR of the panel. Typically the feeder circuit will have an OCPD and we must consider its current-limiting effects on the circuit.

The feeder OCPD may limit fault currents enough so that the weakest link components are protected and the panel can have a higher overall SCCR. For more information please contact Mersen Technical Services at 978-462-6662 or technicalservices.nby@mersen.com.

11 REASONS FOR USING CURRENT-LIMITING FUSES:

Arc Flash Reduction: Current limiting fuses, when applied within their current limiting range, reduce personnel exposure to incident arc flash energy. Non fused systems may need extensive

re-engineering to reduce arc flash hazards, and improve personnel safety.

Safety: Overcurrent protective devices which operate are often reset without first investigating to find the cause of opening. Electromechanical devices which have opened high level faults may not have the reserve capacity to open a 2nd or 3rd fault safely. When a fuse opens it is replaced with a new fuse, thus protection is not degraded by previous faults.

Reliability: No moving parts to wear or become contaminated by dust, oil or corrosion.

Long Life: The speed of response of a fuse will not change or slow down as the fuse ages. In other words, the fuse’s ability to provide protection is not adversely affected by the passage of time.

Minimal Maintenance: Fuses do not require periodic recalibration as do electromechanical overcurrent protective devices.

Component Protection: The current limiting action of a fuse minimizes or eliminates component damage.

North American Standards: Tri-national Standards specify fuse performance and maximum allowable fuse I_p and I^2t let-thru values.

Selectivity: Fuses may be easily coordinated to provide selectivity under both overload and short circuit conditions.

High Interrupting Rating: You don’t pay a premium for high interrupting capacity.

Most low voltage current limiting fuses have a 200,000 ampere interrupting rating.

Cost Effective: Fuses are generally the most cost effective means of providing overcurrent protection. This is especially true where high fault currents exist or where small components need protection.

Extended Protection: Devices with low interrupting ratings are often rendered obsolete by service upgrades or increases in available fault current. Non-fused systems may need expensive system upgrades to maintain system safety.

THREE CLUES FOR DETECTING WHEN IS A FUSE TOO OLD FOR STOREROOM INVENTORY

Storeroom managers often have the responsibility for identifying obsolete inventory. There are advantages to having the right inventory for needs, without the clutter of fuses that should never be used. Obsolete fuses can mask stock-out of important spare fuses resulting in needless emergencies. Sometimes, an electrician will mistakenly use an obsolete fuse and create a dangerous safety condition.

What conditions would make a fuse obsolete? There is functional obsolescence, concealed damage obsolescence, and age obsolescence. Any of these conditions justify discarding a fuse. The electrical safety experts at Mersen offer the following three clues for determining when a fuse should be removed from storeroom inventory:

1. Functional Obsolescence

Functional obsolescence occurs when the fuse can't protect the equipment due to changes in the electrical system, or when the end-use equipment needing this particular fuse has been abandoned. Either way, the fuse will not help in restoring the equipment to service. If it's accidentally used by an electrician, it could create a hazardous situation.

An example of a functionally obsolete fuse is a One-Time with a safety rating of only 10kA IR. When the fuse was originally purchased, it could have had an adequate safety rating. Now the electrical system has changed and requires a safety rating of more than 10kA. If the fuse is installed without adequate IR as required by OSHA, it could explode or cause personal injury.

2. Concealed Damage

Obsolescence can be caused by concealed damage. An electrician normally only checks for fuse continuity to determine its suitability for continued service. But other concealed damage can occur in storage. The biggest threat to fuses in storage is moisture.

Once fuses absorb too much moisture, they lose their interrupting (safety) capacity. Even if they are dried out after the exposure, they are permanently damaged. In normal use they generate enough heat to keep themselves safe from absorbing moisture, but not in storage. The absorption of moisture permanently changes the structure of the filler packing around the fuse link and consequently decreases the safety capacity.

A common check for water damage is to check for wrinkling on the fuse's paper label. If the paper label is wrinkled, it indicates excessive moisture during storage. Also, any water stains on the fuse body or corrosion on the ends can indicate moisture damage.

Other concealed damage can occur when a fuse is used and returned to the storeroom. Any fuse that show scratches on the blades or ferrules was probably inserted into fuse clips and returned to inventory.

3. Fuses Over 10 Years Old

When fuses are more than 10 years old, the history of these fuses is uncertain. More than likely, they were exposed to moisture or damaging conditions sometime during the 10 years of storage. This would make them unsafe and unreliable for maintenance. Most manufacturers mark a date code on their fuses.

Summary

If storeroom fuses exhibit functional obsolescence, signs of moisture damage, or are more than 10 years old, they should be replaced. For a free fuse audit and inventory analysis, visit call 978-462-6662.

1.0 General

The electrical contractor shall furnish and install a complete set of fuses for all fusible equipment on the job as specified by the electrical drawings. Final tests and inspections shall be made prior to energizing the equipment. This shall include tightening all electrical connections and inspecting all ground conductors. Fuses shall be as follows:

2.0 Mains, Feeders and Branch Circuits

A. Circuits 601 to 6000 amperes shall be protected by current-limiting Mersen Amp-Trap 2000® Class L time-delay A4BQ fuses. Fuses shall be time-delay and shall hold 500% of rated current for a minimum of 4 seconds, clear 20 times rated current in .01 second or less and be UL Listed and CSA Certified with an interrupting rating of 200,000 amperes rms symmetrical.

B. Circuits 600 amperes or less shall be protected by current-limiting Mersen Amp-Trap 2000® Class RK1 time-delay A2D (250V) or A6D (600V) or Class J time-delay AJT fuses. Fuses shall hold 500% of rated current for a minimum of 10 seconds (30A, 250V Class RK1 case size shall be a minimum of 8 seconds) and shall be UL Listed and CSA Certified with an interrupting rating of 200,000 amperes rms symmetrical.

C. Motor Protection

All individual motor circuits shall be protected by Mersen Amp-Trap 2000® Class RK1, Class J or Class L time-delay fuses as follows:

Circuits up to 480A: Class RK1 - A2D (250V) or A6D(600V)
Class J - AJT

Circuits over 480A: Class L - A4BQ

Fuse sizes for motor protection shall be chosen from tables published by Mersen for the appropriate motor rating. Heavy load and maximum fuse ratings are also shown for applications where typical ratings are not sufficient for the starting current of the motor.

D. Motor Controllers

Motor controllers shall be protected from short circuits by Mersen Amp-Trap 2000® time-delay fuses. For Type 2 protection of motor

controllers, fuses shall be chosen in accordance with motor control manufacturers' published recommendations, based on Type 2 test results. The fuses shall be Class RK1 A2D (250V) or A6D (600V) or Class J AJT or Class CC ATDR (600V).

- E. Circuit breakers and circuit breaker panels shall be protected by Mersen Amp-Trap 2000® fuses Class RK1 (A2D or A6D), Class J (AJT) or Class L (A4BQ) chosen in accordance with tested UL Series-connected combinations published in the current yellow UL Recognized Component Directory.
- F. Supplementary lighting and control circuits in the connected combinations shown up to 600VAC and 24 amps shall be protected by Mersen Amp-Trap 2000® Class CC time-delay ATQR or ATDR fuses, sized according to the fixture manufacturers recommendations.

3.0 Spares

Spare fuses amounting to 10% (minimum three) of each type and rating shall be supplied by the electrical contractor. These shall be turned over to the owner upon project completion. Fuses shall be contained and cataloged within the appropriate number of spare fuse cabinets (no less than one). Spare fuse cabinets shall be equipped with a key lock handle, be dedicated for storage of spare fuses and shall be GSFC, as supplied by Mersen.

4.0 Execution

- A. Fuses shall not be installed until equipment is to be energized. All fuses shall be of the same manufacturer to assure selective coordination.
- B. As-installed drawings shall be submitted to the engineer after completion of the job.
- C. All fusible equipment rated 600 amperes or less shall be equipped with fuse clips to accept Class RK1 or Class J fuses as noted in the specifications.

5.0 Substitution

Fuse sizes and types indicated on drawings are based on Mersen Amp-Trap 2000® fuse current-limiting performance and selectivity ratios. Alternative submittals to furnish materials other than those specified, shall be submitted to the engineer in writing two weeks prior to bid date, along with a short circuit and selective coordination study.