

TELECOMMUNICATIONS

SPECIAL PURPOSE FUSES



Ferraz Shawmut telecommunications fuses are specially designed for the protection of telecommunications equipment which includes telephone switching equipment, rectifiers, distribution switching panels, battery back-up modules, power supplies and switching sub-stations.

The telecom fuses are available from 1 to 800 amperes rated at 170VDC with an interrupting rating of 100,000 amps to fulfill your circuit protection needs. The telecom fuses have high current limiting capabilities to provide a better degree of circuit protection to traditional telecommunications equipment. These fuses consist of a blue and white label for easy identification of their DC voltage capability.

HIGHLIGHTS

- DC Rated
- Highly Current Limiting
- Fast Acting
- Rejection Style

APPLICATIONS:

- Distribution Switching Panels
- Battery Back-up Systems
- Power Supplies
- Switching Substations
- Telephone Switching Rectifiers

Ratings

- TGL: 70-800 A
170VDC,
100kA I.R.
- TGN: 1-600 A
170VDC,
100kA I.R.
- TGS: 1-70 A
170VDC,
100kA I.R.

Approvals

- UL Recognized Components
- File #E60314

Features/Benefits

- All fuses rated 170VDC, 100kA I.R.
- Extremely current limiting
- Blue & white labels for easy identification
- Various mounting configurations

Telecom Fuse Cross Reference

Competitor Part Number	Ferraz Part Number
TPL	TGL
TPN	TGN
TPS	TGS

Recommended Fuse Holder

FUSE	AMPERE	1 Pole	3 Pole
TGL	70-250A	P243D	
	300-800A	P243G	
TGN	0-30	20306R	20308R
	31-60	20606R	20608R
	61-100	21036R	21038R
	101-200	22001R	22003R
	201-400	24001R	24003R
	401-600	2631R	2633R
TGS	0-70A	30656T	30658T

TGN

TELECOMMUNICATIONS/SPECIAL PURPOSE

Catalog Numbers, Standard Ampere Rating

Catalog Number	Ampere Rating	Catalog Number	Ampere Rating	Catalog Number	Ampere Rating
TGN1	1A	TGN40	40A	TGN175	175A
TGN3	3A	TGN45	45A	TGN200	200A
TGN5	5A	TGN50	50A	TGN225	225A
TGN6	6A	TGN60	60A	TGN250	250A
TGN10	10A	TGN70	70A	TGN300	300A
TGN15	15A	TGN80	80A	TGN350	350A
TGN20	20A	TGN90	90A	TGN400	400A
TGN25	25A	TGN100	100A	TGN450	450A
TGN30	30A	TGN110	110A	TGN500	500A
TGN35	35A	TGN150	150A	TGN600	600A

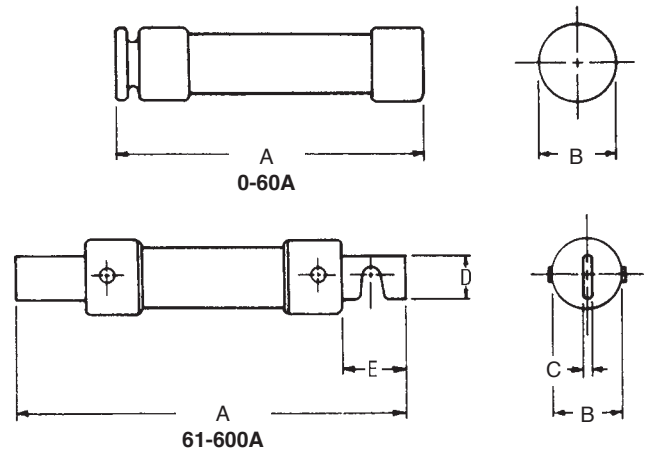

Dimensions

AMPERE RATING	A		B		C		D		E	
	In.	mm	In.	mm	In.	mm	In.	mm	In.	mm
170 VDC TGN FUSES										
0-30	2	51	9/16	14						
31-60	3	76	13/16	21						
61-100	5-7/8	149	1-1/16	27	1/8	3	3/4	19	1	25
101-200	7-1/8	181	1-9/16	40	3/16	5	3/4	19	1-3/8	35
201-400	8-5/8	219	2-1/16	53	1/4	6	1-5/8	41	1-7/8	48
401-600	10-3/8	264	2-9/16	66	1/4	6	2	51	2-1/4	57

Melting Time - Current Data

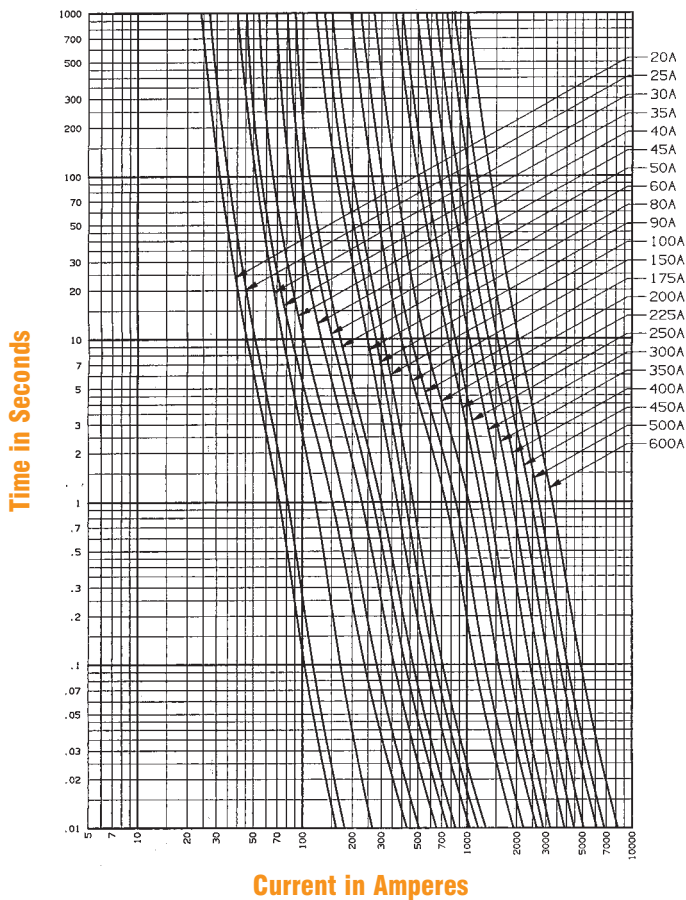

G

Catalog Number, Standard Ampere Rating

Catalog Number	Ampere Rating	Catalog Number	Ampere Rating
TGL-BA	70A	TGL-BL	250A
TGL-BB	80A	TGL-CN	300A
TGL-BC	90A	TGL-CO	350A
TGL-BD	100A	TGL-CR	400A
TGL-BE	125A	TGL-CU	450A
TGL-BF	150A	TGL-CV	500A
TGL-BG	175A	TGL-CZ	600A
TGL-BH	200A	TGL-CZH	800A
TGL-BK	225A		

Dimensions

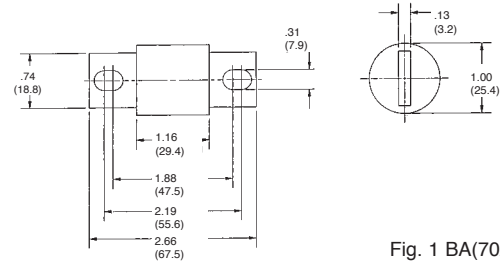

Fig. 1 BA(70A) – BL(250A)

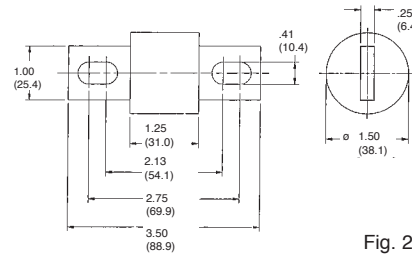
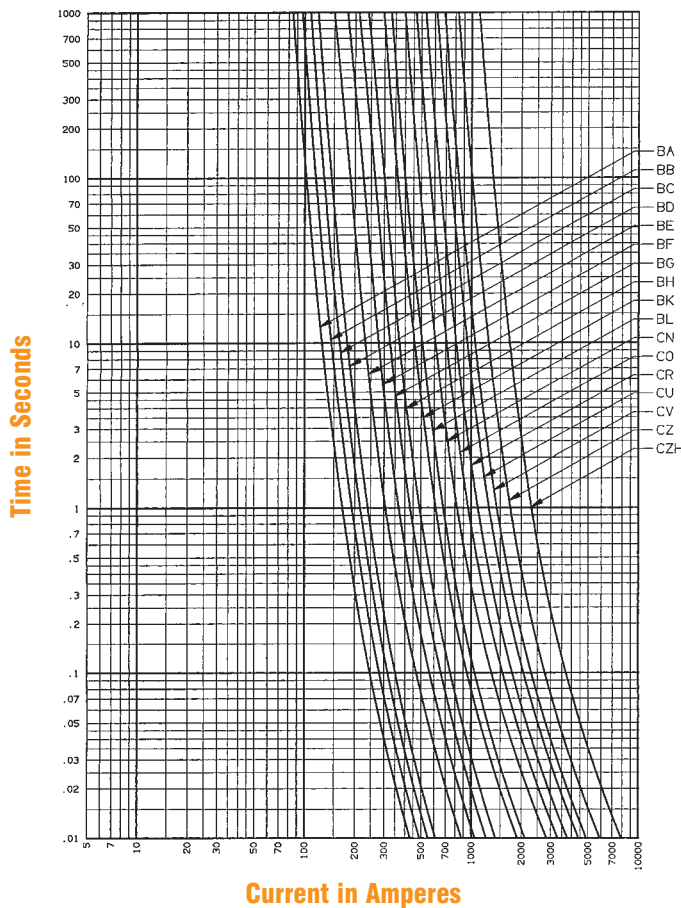

Fig. 2 CN(300A) – CZH(800A)

Melting Time - Current Data



TGS

TELECOMMUNICATIONS/SPECIAL PURPOSE FUSES

Catalog Numbers, Standard Ampere Rating

Catalog Number	Ampere Rating	Catalog Number	Ampere Rating
TGS1	1A	TGS20	20A
TGS2	2A	TGS25	25A
TGS3	3A	TGS30	30A
TGS5	5A	TGS40	40A
TGS6	6A	TGS50	50A
TGS10	10A	TGS60	60A
TGS15	15A	TGS70	70A

Dimensions

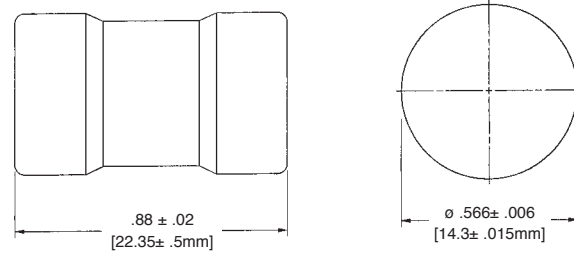

Peak Let - Thru Current Data

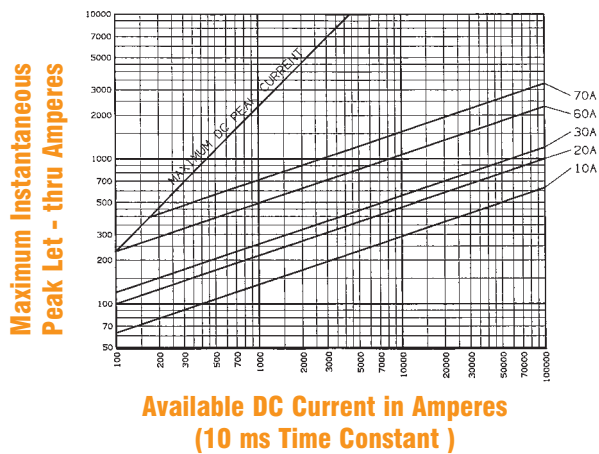

Melting Time - Current Data

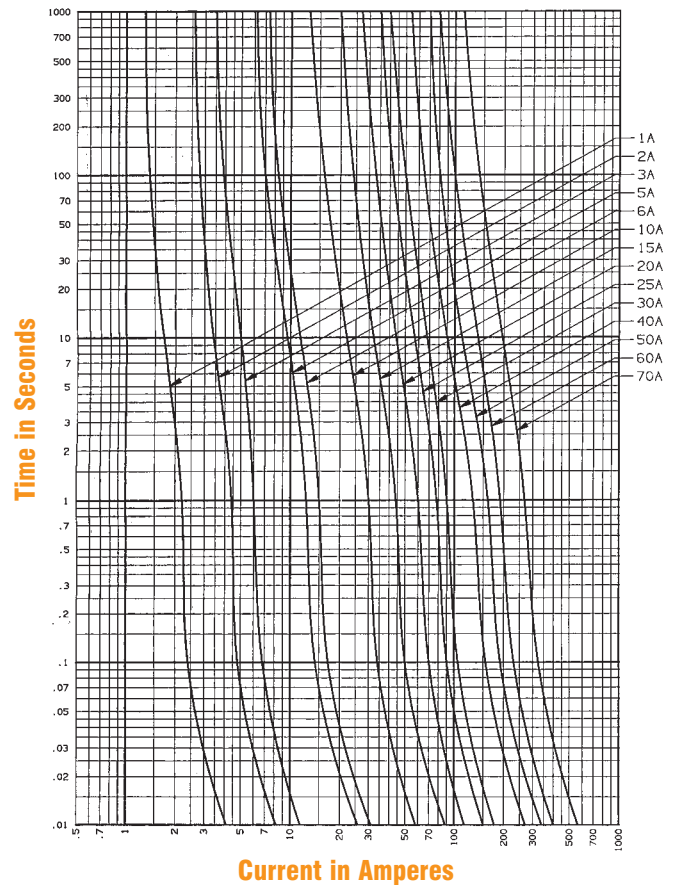

G